



Hall® Powered Instruments System™

Product Catalog



MICROPOWER®
SAW



MICRO 100™
SURG AIR TOME TWO™

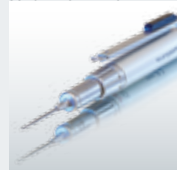

M-CLASS™
BLADES

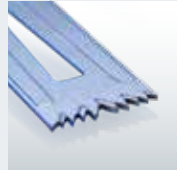

HALL® LITHIUM
BATTERIES



HALL®
POWERED INSTRUMENTS

| | | | |
|---|---------|---|-----------|
| Ordering Information..... | 2 | Micro Sagittal Saw Blades | 45 - 49 |
| Product Support..... | 3 | Micro Oscillating Saw Blades | 50 - 52 |
| Product Support & Service Programs | 4 | Micro Reciprocating Saw Blades & Rasps..... | 53 |
| Return/Repair Information..... | 5 | Micro Burs | 54 - 56 |
| Hall 50™ | 6 | Sternum Saws..... | 57 |
| Indications for Use: Large Bone & Small Bone Orthopaedics | | Sternum Saw Blades | 58 - 60 |
| MPower® 2 | 7 | Indications for Use: Primary & Repeat Sternotomy | |
| Indications for Use: Large Bone & Small Bone Orthopaedics | | Ultrapower®..... | 61 |
| Batteries & Accessories..... | 8, 9 | Indications for Use: Spine & Neuro | |
| PowerPro® & PowerPro Electric II™ | 10 | UltraPower Burs | 62 - 66 |
| Indications for Use: Large Bone & Small Bone Orthopaedics | | Indications for Use: Otology (Round Burs Only), Spine & Neuro | |
| PowerPro® Pneumatic | 11 | E9000® System..... | 67 |
| Indications for Use: Large Bone & Small Bone Orthopaedics | | Indications for Use: ENT, Spine & Neuro | |
| Pin and Wire Drivers..... | 12 | E9005 ENT Shaver Blades..... | 68 - 71 |
| Indications for Use: Large Bone & Small Bone Orthopaedics | | Indications for Use: Sinus Surgery | |
| Attachments..... | 13 | E Burs..... | 72, 73 |
| Indications for Use: Large Bone & Small Bone Orthopaedics | | Indications for Use: Otology, Spine & Neuro | |
| Sterilization Trays..... | 14 | Osteon™ | 74 |
| Indications for Use: Large Bone Orthopaedics | | Indications for use: ENT | |
| M-Class® Blades..... | 15 | Osteon Burs | 75 |
| Indication for Use: Total Knee Arthroplasty | | Indications for use: Otology | |
| Hall® Classic Blades | 16 | Cebotome® | 76 |
| Indication for Use: Total Knee Arthroplasty | | Indications for use: Large Bone Revision Surgery | |
| Intrex® Blade System..... | 17 | Cebotome® Burs & Metal Cutting Accessories..... | 77 |
| Indication for Use: Total Knee Arthroplasty | | Indication for Use: Large Bone Revisions Surgery | |
| Stryker Replacement Blades | 18 | Wires & Staples..... | 78 |
| Indication for Use: Total Knee Arthroplasty | | Indication for Use: Small Bone Trauma | |
| Large Bone Knee Blades..... | 19 - 30 | Miscellaneous Accessories | 79 |
| Indication for Use: Total Knee Arthroplasty | | Electric Consoles & Accessories..... | 80, 81 |
| Large Bone Oscillating Blades..... | 31 - 33 | Pneumatic Regulators, Hoses & Accessories | 82 |
| ACL Blades | | Kit Listings | 83 - 86 |
| Large Bone Oscillating Blades..... | 34, 37 | Numerical Index..... | 88 - 107 |
| Indications for Use: Total Hip Arthroplasty & Large Bone Trauma | | Alphabetical Index | 108 - 127 |
| Large Bone Reciprocating Blades..... | 38, 39 | | |
| Indications for Use: Total Joint Arthroplasty & Large Bone Trauma | | | |
| MicroPower™ + | 40 | | |
| Indications for Use: Small Bone | | | |
| MicroPower®..... | 41 | | |
| Indications for Use: Small Bone | | | |
| Micro 100™ | 42 | | |
| Indications for Use: Small Bone | | | |
| Attachments & Bur Guards | 43 | | |
| For Use with Micro Handpieces | | | |
| Sterilization Trays..... | 44 | | |
| For Use with Micro Handpieces | | | |

Terms

ConMed standard terms are net thirty (30) days, F.O.B. shipping point, unless otherwise approved in writing by ConMed. All orders and transactions are subject to the laws of the state of Florida.

To Place Your Order

Please provide a purchase order number, billing and shipping instructions, product catalog number and description, valid ConMed quotation, and quantity and pricing to one of the following:

Your Sales Representative

Customer Service

Phone: 800-237-0169

Fax: 727-399-5256

E-mail: custserv1@conmed.com

ConMed

Attn: Customer Service

11311 Concept Boulevard

Largo, FL 33773-4908 USA

True Purchasing Flexibility

ConMed Financial Services offers a variety of flexible financing programs, from leases to Pre-Procedure Programs to delayed payment plans. Ask your Sales Representative for more information on how you can acquire the latest technology through a financing program that fits your unique budgetary requirements.

Rental Program for Instrument Sets & Capital Equipment

In every O.R., there are times when you have to schedule a case but do not have the equipment needed. Either the capital funding for the equipment has yet to be approved or you have been unable to justify the cost of the equipment due to the procedure's low volume.

For these situations, ConMed offers a rental program for procedure-specific instruments and capital equipment. Simply call ConMed at 888-587-9742 and everything that you need for the case is on its way.

To enroll in a rental program, contact your Sales Representative or call the ConMed field inventory team. Your representative will help you customize the kit(s) to fit your procedural requirements. After the case, simply return the instruments, cleaned and sterilized if appropriate, along with any disposables you did not use. The rental fee will be billed for the disposables not returned, and customer will be responsible for any expedited shipping cost.

Failure to return instrumentation/equipment at the end of the rental period will result in the customer being charged the standard rental fee automatically for each week that the instrumentation/equipment is not received by ConMed.

At ConMed, we want to offer more than a quality product. We take pride in being able to provide you with value added services to support our products. The information given in this catalog is designed to address your questions regarding product support.

Customer Support

If you encounter a problem or need technical assistance, contact Customer Service (Product Support) or your Sales Representative. Refer to the Customer Service telephone numbers listed.

Regulatory Compliance

Report any injuries or malfunctions to ConMed Customer Service. Refer to the Customer Service telephone numbers listed.

Original Warranty

ConMed (the “Company”) warrants to the first purchaser or lessee (“You” or “Customer”) that the instruments, attachments and parts manufactured by or for the Company (hereinafter collectively “Instruments”) have been tested, inspected, and shipped in proper working order.

The Company warrants all new instruments to be free from defects in materials and workmanship for the following periods, measured from date of sale*:

| Product Categories | Months |
|--|---------------|
| All Single Use Products..... | Upon Receipt |
| Powered Surgical Instruments..... | 12 |
| Power Attachments and Accessories..... | 12 |
| Handpiece Cords and Power Cords..... | 6 |
| Pneumatic Hoses..... | 6 |
| Bur Guards, Blade Guards, Attachments..... | 6 |
| Battery Packs and Accessories..... | 3 |
| Battery Chargers..... | 12 |
| Camera Consoles..... | 12 |
| Video Components..... | 12 |
| Video Cables and Light Guides..... | 3 |
| Scopes..... | 12 |
| Camera Heads..... | 12 |
| Instruments..... | 12 |
| Instrument Tray..... | 3 |
| Footswitches..... | 12 |
| Irrigation Systems (Pumps and Remotes)..... | 12 |
| Reusable Procedure Specific Instruments..... | 6 |

Following the Original Warranty, ConMed offers additional warranty and service programs that support our products throughout their lifetime. Service programs address the necessity to control cost and greatly reduce repair turnaround time by eliminating the need for repair quotes. Products not covered under a service program are subject to variable repair charges. To find out which service option best meets your needs, contact your local Sales Representative.

Service Agreements

Service Agreements provide additional service coverage on capital equipment. This additional warranty period covers all repair costs, periodic maintenance, free loaner usage during repair time and freight charges out from ConMed both on the loaner product and the repaired instrument.

Service Warranty

After expiration of the Original or Service Agreement period, instruments may be returned to ConMed for repair at the customer’s expense. ConMed warrants that any service or repair work performed by ConMed shall be free from defects in workmanship and materials for a period of 90 days after the date the customer receives the Instrument(s). This limited warranty applies only to the actual service or repair work performed by ConMed or its authorized service centers. ConMed warrants that all parts and assemblies used in the repair or service of Instruments meet new part functional specifications, although some parts or assemblies may have been remanufactured.

ConMed components are manufactured to exacting tolerances and design specifications. As a standard practice, all repairs are subject to strict product performance and testing specifications prior to returning the Instrument to the customer. ConMed ensures that each Instrument is inspected according to the guidelines used for new manufactured Instruments. If an Instrument is determined unrepairable, ConMed will offer to sell to the customer a refurbished or brand new Instrument or comparable equivalent at a preferential price. All parts and assemblies replaced by ConMed shall become the property of ConMed.

Repair Quotes

Upon request Customer Service can estimate the repair charges for non-warranty repairs. If a firm repair quote is requested, please return your product for inspection and you will be contacted before the repair is initiated. If a product is returned and a firm quote is not requested, the repair will be processed and your account billed accordingly.

Minimum Service Charge

There is a minimum repair charge for the evaluation and testing of all returns (except for products covered under warranty).

Return Shipping

All repaired products will be returned to you via second day air delivery unless you request an alternate shipping method. The cost of return shipping is your responsibility unless the product is under warranty or service agreement.

* Effective February 1, 2014

Warranty Terms

If the customer discovers within the warranty period (Original or Service Agreement) that an Instrument has a defect in materials and/or workmanship, the customer must promptly notify the Company. Also, if the customer discovers within the service warranty period that any service or repair work performed by ConMed has a defect in workmanship and/or materials, the customer must promptly notify the Company. If it becomes necessary to return the Instrument to the Company, the customer must (a) acquire a "Service Request" (SR) authorization from the Company Customer Service Department, (b) pack the unit carefully, and (c) return it to the Company.

Within a reasonable time after receipt of the Instrument, the Company will investigate and correct any defect covered by warranty by providing, at its option, one of the following: service or repair of the Instrument, or replacement of the Instrument. All parts and assemblies replaced by ConMed shall become the property of ConMed. These remedies are the customer's exclusive remedies under the warranty.

The foregoing limited warranties do not apply to:

- » Instruments that have been tampered with, altered, neglected, or misused,
- » Instruments damaged through use with other than Company authorized accessories, attachments, burs or blades,
- » Instruments not manufactured by or for the Company,
- » Instruments used for purposes other than those for which they were designed and manufactured, including use in any way inconsistent with the instructions and warnings contained in the Company instruction manuals and package inserts, and
- » Instruments that were last serviced, refurbished, reprocessed or reconditioned by a nonauthorized service entity.

THE FOREGOING LIMITED WARRANTIES ARE IN LIEU OF ALL OTHER WARRANTIES, EXPRESS OR IMPLIED, INCLUDING, BUT NOT LIMITED TO, THE IMPLIED WARRANTIES OF MERCHANTABILITY AND FITNESS FOR A PARTICULAR PURPOSE.

In no case shall the Company be liable for any special, incidental, indirect or consequential damages based upon breach of warranty or any other legal theory. Some jurisdictions do not allow limits on warranties, or on remedies, and, in such jurisdictions, the limits in this and the preceding paragraphs may not apply.

The Company reserves the right (a) to make design changes to Instruments at any time without notice to customer and without incurring any obligation to incorporate those changes into Instruments previously purchased or leased, and (b) to make changes from time to time in the contents of any publication, instruction manual or package insert without any obligation to notify customers of such revisions or changes, and (c) to change price without notice.

U.S. Procedure for Returns/Repairs

1. All Instruments must be cleaned and sterilized, if appropriate, prior to return of any Instrument to ConMed. Instruments contaminated with biohazardous materials will be returned to you at your expense.
2. An authorized Service Request (SR) Number must be obtained prior to returning any Instrument for repair/return.
3. To return a product for repair, contact ConMed Customer Service. The following information is needed to process a repair/return:
 - » Catalog Number
 - » Serial/Lot Number
 - » Original Invoice Number
 - » Detailed description of the problem or reason for return
4. The SR number must be displayed on the outside of the box, included with all paperwork, and must be referred to when making an inquiry about the status of a repair/return.
5. ConMed maintains various repair centers around the world. When you are issued your SR number, you will be advised of the location where to send your product.

Return Terms

If it becomes necessary to return a product after purchase, the product must be returned within 45 days of its ship date. The product must be returned unused, in the original packaging and be restockable. Returns must be shipped prepaid freight. Returns that are not shipped prepaid freight will not be accepted. All product returns, except those attributable to a ConMed error, are subject to a restocking fee of 15% of the purchase price or \$25, whichever is greater.

Products Not Eligible for Credit:

- » Sterile products/single use devices returned with the outer packaging seals broken
- » Non-sterile products that have been sterilized and/or placed in the surgical field
- » Products damaged by customer misuse or negligence
- » Altered or customized products
- » Products damaged in return transit due to inadequate packaging
- » Less than full packages – all products must be in original packaging
- » Obsolete products

Packaging

Whenever it is required to return your product, be sure to package it in a protective carton. We recommend that you save the original shipping container for this purpose. In-transit damage is not covered by the warranty; therefore, it is best to always insure shipments.

Hall 50™

Indications for Use: Large Bone
& Small Bone Orthopaedics



Attachments Listed on Pages 12 and 13

| | Cat. No. |
|---|----------|
| Hall 50 1-Trigger Modular Handpiece | PRO7100B |
| Hall 50 2-Trigger Modular Handpiece | PRO7200B |



PRO7100B



PRO7200B



PRO7300B



PRO7400B

| | |
|---|----------|
| Hall 50 Oscillating Saw Handpiece | PRO7300B |
|---|----------|

| | |
|---|----------|
| Hall 50 Reciprocating Saw Handpiece | PRO7400B |
|---|----------|

Attachments Listed on Pages 12 and 13

| | Cat. No. |
|--|----------|
| Single Trigger Modular Handpiece | PRO6200M |
| 2-Trigger Modular Handpiece | PRO6202M |

Oscillating Saw

PRO6350M

Reciprocating Saw

PRO6400M



PRO6200M

PRO6202M



PRO6350M

PRO6400M

All products may not be available in all markets.



L3000

Hall® Lithium Charger Cat. No. L3000



L3000SM

L3000LG

Hall Large Lithium Battery, 13.2 Volt L3000LG
 Hall Small Lithium Battery, 13.2 Volt L3000SM



PRO3600

NiCad Battery Charger PRO3600



PRO3020

Small NiCad Battery, 12 Volt PRO3020



PRO3010



PRO3011

Large NiCad Battery, 9.6 Volt PRO3010
 X-Large NiCad Battery, 12 Volt PRO3011

All products may not be available in all markets.

| | Cat. No. |
|--|----------|
| Small NiMH Sterile Transfer Battery, 12 Volt | PRO3520 |
| Large NiMH Sterile Transfer Battery, 9.6 Volt..... | PRO3115 |

| | |
|--------------------------------|---------|
| Battery Case for PRO3520 | PRO3521 |
| Battery Case for PRO3115..... | PRO3110 |

| | |
|-----------------------------------|---------|
| Transfer Shroud for PRO3521 | PRO3531 |
| Transfer Shroud for PRO3110 | PRO3130 |

| | |
|-------------------------------------|---------|
| Charging Platform for PRO3520..... | PRO3535 |
| Charging Platform for PRO3115 | PRO3135 |



PRO3520



PRO3115



PRO3521



PRO3110



PRO3531



PRO3130



PRO3535



PRO3135

All products may not be available in all markets.

PowerPro® & PowerPro Electric II™

Indications for Use: Large Bone
& Small Bone Orthopaedics



PRO6100

Attachments Listed on Pages 12 and 13

Cat. No.

Single Trigger Modular Handpiece PRO6100



PRO6125

Oscillating Saw PRO6125



PRO6135

Reciprocating Saw PRO6135

All products may not be available in all markets.

Attachments Listed on Pages 12 and 13

Single Trigger Modular Handpiece Cat. No. PRO6150

Oscillating Saw PRO6175

Reciprocating Saw PRO6185



PRO6150



PRO6175



PRO6185

All products may not be available in all markets.

Pin and Wire Drivers

Indications for Use: Large Bone
& Small Bone Orthopaedics



PRO6128



PRO6140



PRO6228



PRO6240

Single Trigger Wire and Pin Drivers

Cat. No.

Wire Driver, Range: 0.7 – 1.6mm (0.028 – 0.062")..... PR06128

Pin Driver, Range: 1.8 – 4.0mm (0.071 – 0.157") PR06140

2-Trigger Wire and Pin Drivers

Wire Driver Range: 0.7 – 1.6mm (0.028 – 0.062")..... PR06228

Pin Driver Range: 1.8 – 4.0mm (0.071 – 0.157")..... PR06240

Drill-Ream 1:1/5:1 Combination Attachments



Drill-Ream Attachment, AO
Cat. No. PRO1540



Drill-Ream Attachment, 1/4" (6.35mm) Chuck
Cat. No. PRO1541



Drill-Ream Attachment, Zimmer/Hudson
Cat. No. PRO1547



Drill-Ream Attachment, DePuy/Hudson
Cat. No. PRO1548

1:1 Multipurpose Attachments



1/2" (4.0mm) Jacobs Chuck, with Chuck Key
Cat. No. PRO2030



1/2" (4.0mm) Replacement Chuck Key
Cat. No. 5044-999-53



1/4" (6.35mm) Jacobs Chuck
Cat. No. PRO2041



1/4" (6.35mm) Replacement Chuck Key
Cat. No. 5044-999-52



1/4" Keyless Chuck
Cat. No. PRO6050



1/4" Keyless Chuck
Cat. No. PRO2250

1:1 Quick Connect Drill Attachments



AO/Trinkle
Cat. No. PRO2029



Small AO-Low Profile
Cat. No. PRO2038



Small AO-One Handed Operation
Cat. No. PRO2138



Zimmer/Hudson
Cat. No. PRO2046



Large AO
Cat. No. PRO2070



Standard Hudson (DePuy)
Cat. No. PRO2075



Mini AO
Cat. No. PRO2039

3:1 Reamers



3:1 1/4" High Torque Jacobs Chuck
Cat. No. PRO2042



3:1 Zimmer/Hudson Reamer
Cat. No. PRO2047



3:1 Hudson Reamer (DePuy)
Cat. No. PRO2065



3:1 Large AO Reamer
Cat. No. PRO2040



3:1 Aesculap Reamer
Cat. No. PRO2060



3:1 DHS Reamer
Cat. No. PRO2080



3:1 Trinkle Reamer
Cat. No. PRO2329

5:1 Reamers



5:1 1/4" High Torque Jacobs Chuck
Cat. No. PRO6042



5:1 Zimmer/Hudson Reamer
Cat. No. PRO6047



5:1 Hudson Reamer (DePuy)
Cat. No. PRO6048



5:1 Large AO Reamer
Cat. No. PRO6040



5:1 Aesculap Reamer
Cat. No. PRO6060

Miscellaneous Attachments



Radiolucent Drive Adaptor
Cat. No. PRO2514



High Speed Drill Attachment
Cat. No. PRO2033



Sagittal Saw Attachment
Cat. No. PRO2043



Multipurpose High Speed
Cat. No. PRO7020



Reciprocating Saw Attachment for PRO6100, PRO6150, PRO6200M, & PRO6202M
Cat. No. PRO6045

Sterilization Trays

Indications for Use: Large Bone Orthopaedics



TR34R with PRO7000T



TR34R with PRO7001T,
and PRO7002T



TR12R with PRO7001T



TR12R with PRO7002T

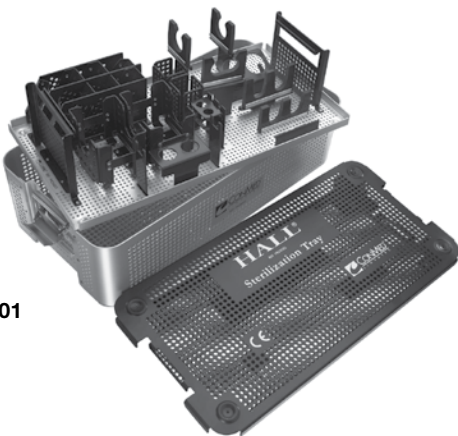

PRO6001

Hall 50™ Sterilization Containers

Cat. No.

| | |
|--|-------|
| ¾ Size Rigid Sterilization Container | TR34R |
| ½ Size Rigid Sterilization Container | TR12R |

Hall 50 Sterilization Inner Trays

| | |
|------------------------------------|----------|
| ¾ Size Inner Tray, Full Set | PRO7000T |
| ½ Size Inner Tray, Drill Set | PRO7001T |
| ½ Size Inner Tray, Saw Set | PRO7002T |

| | |
|---|---------|
| MPower® 2, Large Bone Tray with Battery Holders | PRO6001 |
|---|---------|

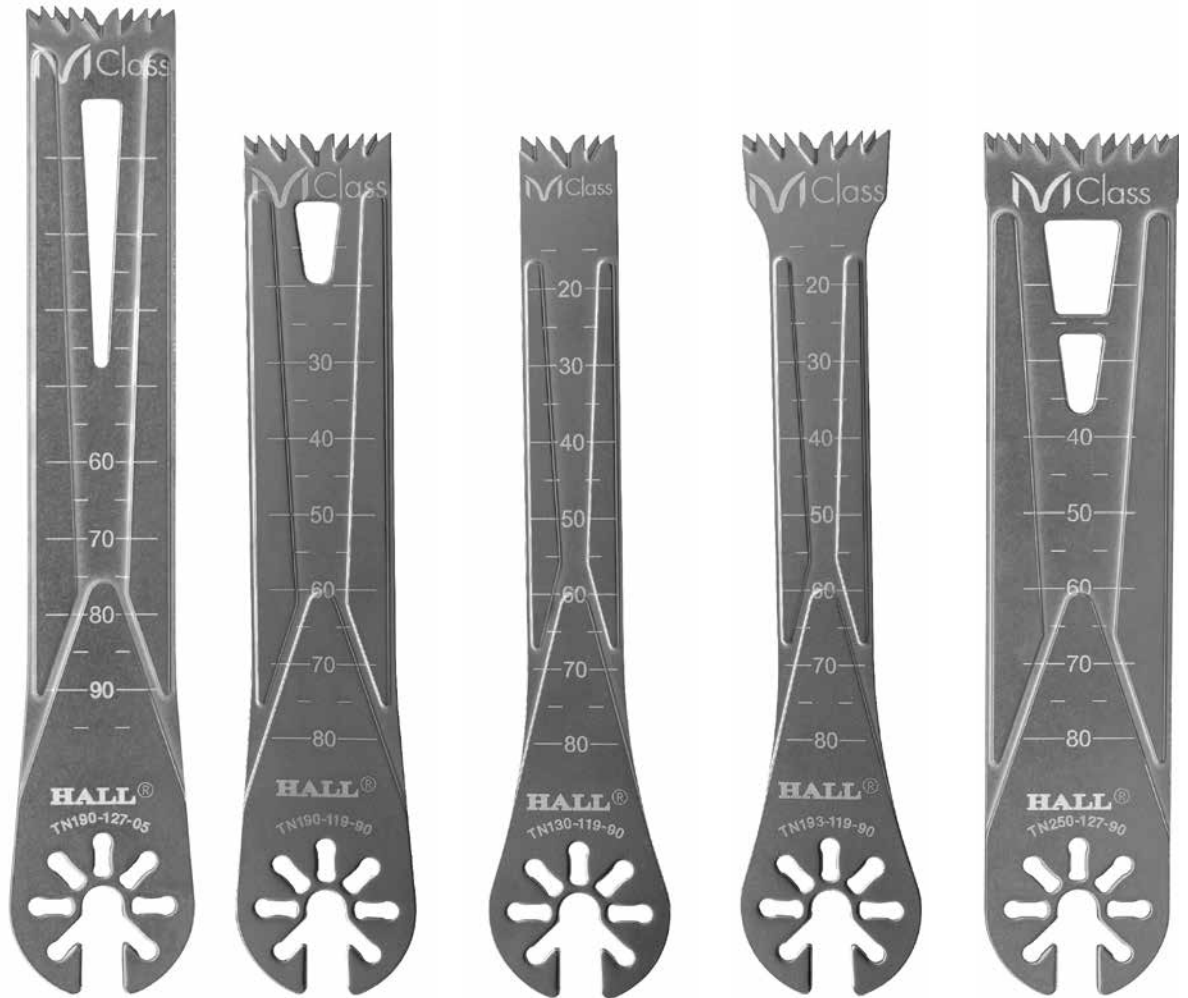

Blades images are 1:1 in length and width.

| | | | | | |
|------------------|------------------------|--------------|--------------|--------------|--------------|
| Body Width | 19.0mm | 19.0mm | 13.0mm | 19.0/13.0mm | 25.0mm |
| Length | 105.0mm | 90.0mm | 90.0mm | 90.0mm | 90.0mm |
| Thickness | Blade Catalog # | | | | |
| 0.89mm | | TN190-089-90 | TN130-089-90 | | TN250-089-90 |
| 1.00mm | | TN190-100-90 | TN130-100-90 | | TN250-100-90 |
| 1.07mm | | TN190-107-90 | TN130-107-90 | | TN250-107-90 |
| 1.19mm | TN190-119-05 | TN190-119-90 | TN130-119-90 | TN193-119-90 | TN250-119-90 |
| 1.27mm | TN190-127-05 | TN190-127-90 | TN130-127-90 | TN193-127-90 | TN250-127-90 |
| 1.37mm | TN190-137-05 | TN190-137-90 | TN130-137-90 | TN193-137-90 | TN250-137-90 |
| 1.47mm | | TN190-147-90 | TN130-147-90 | | TN250-147-90 |

Hall® Classic Blades

Indication for Use: Total Knee Arthroplasty

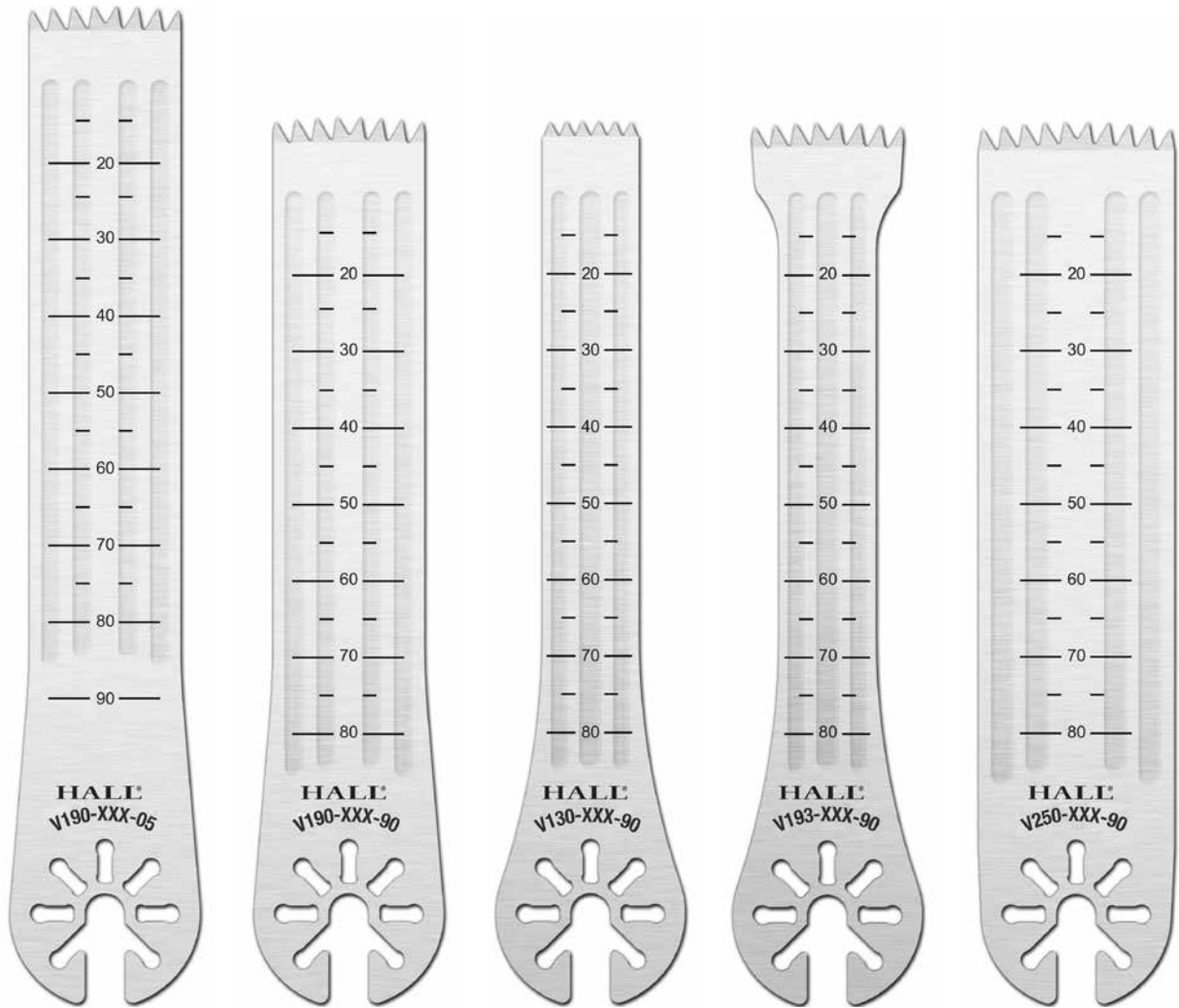

Blades images are 1:1 in length and width.

| Body Width | 19.0mm | 19.0mm | 13.0mm | 19.0/13.0mm | 25.0mm |
|------------|-----------------|-------------|-------------|-------------|-------------|
| Length | 105.0mm | 90.0mm | 90.0mm | 90.0mm | 90.0mm |
| Thickness | Blade Catalog # | | | | |
| 0.89mm | V190-089-05 | V190-089-90 | V130-089-90 | | V250-089-90 |
| 1.00mm | V190-100-05 | V190-100-90 | V130-100-90 | | V250-100-90 |
| 1.07mm | V190-107-05 | V190-107-90 | V130-107-90 | | V250-107-90 |
| 1.19mm | V190-119-05 | V190-119-90 | V130-119-90 | V193-119-90 | V250-119-90 |
| 1.27mm | V190-127-05 | V190-127-90 | V130-127-90 | V193-127-90 | V250-127-90 |
| 1.37mm | V190-137-05 | V190-137-90 | V130-137-90 | V193-137-90 | V250-137-90 |
| 1.47mm | V190-147-05 | V190-147-90 | V130-147-90 | | V250-147-90 |

All products may not be available in all markets.

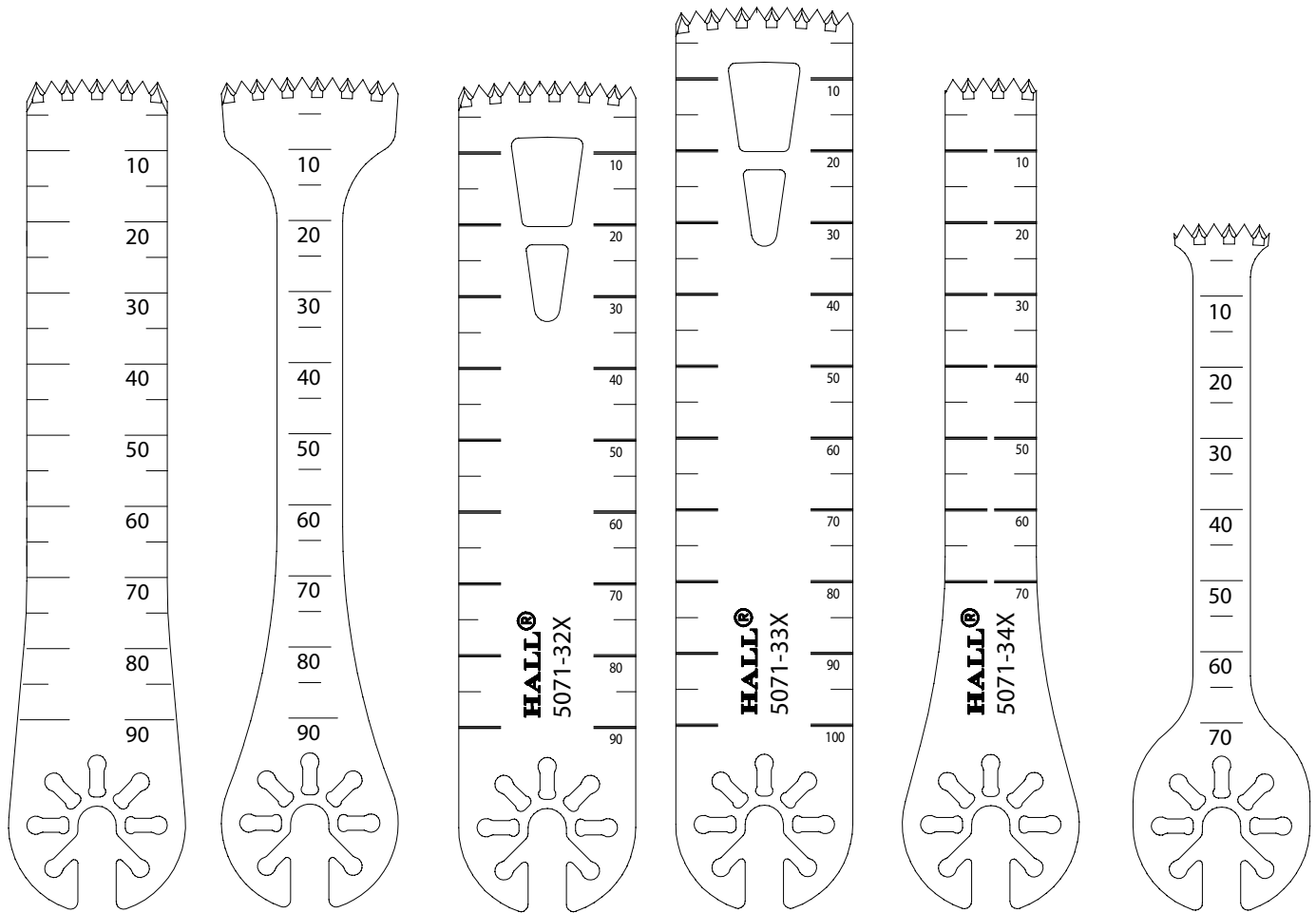

5071-30X

5071-31X

5071-32X

5071-33X

5071-34X

5071-35X

Blades images are 1:1 in length and width.

| | Standard | MIS | Standard/ Wide | Standard/Long | Standard/ Narrow | Unicondylar |
|------------------|------------------------|----------|----------------|---------------|------------------|-------------|
| Head Width | 19.5mm | 25.0mm | 25.0mm | 25.0mm | 12.5mm | 13.0mm |
| Body Width | 19.5mm | 9.0mm | 25.0mm | 25.0mm | 12.5mm | 8.0mm |
| Length | 90.0mm | 90.0mm | 90.0mm | 100.0mm | 90.0mm | 70.0mm |
| Thickness | Blade Catalog # | | | | | |
| 0.89mm | 5071-300 | 5071-310 | 5071-320 | 5071-330 | 5071-340 | 5071-350 |
| 1.00mm | 5071-301 | 5071-311 | 5071-321 | 5071-331 | 5071-341 | 5071-351 |
| 1.07mm | 5071-302 | 5071-312 | 5071-322 | 5071-332 | 5071-342 | 5071-352 |
| 1.19mm | 5071-303 | 5071-313 | 5071-323 | 5071-333 | 5071-343 | 5071-353 |
| 1.27mm | 5071-304 | 5071-314 | 5071-324 | 5071-334 | 5071-344 | 5071-354 |
| 1.37mm | 5071-305 | 5071-315 | 5071-325 | 5071-335 | 5071-345 | 5071-355 |
| 1.47mm | 5071-306 | 5071-316 | 5071-326 | 5071-336 | 5071-346 | 5071-356 |

All products may not be available in all markets.

Stryker Replacement Blades

Indication for Use: Total Knee Arthroplasty

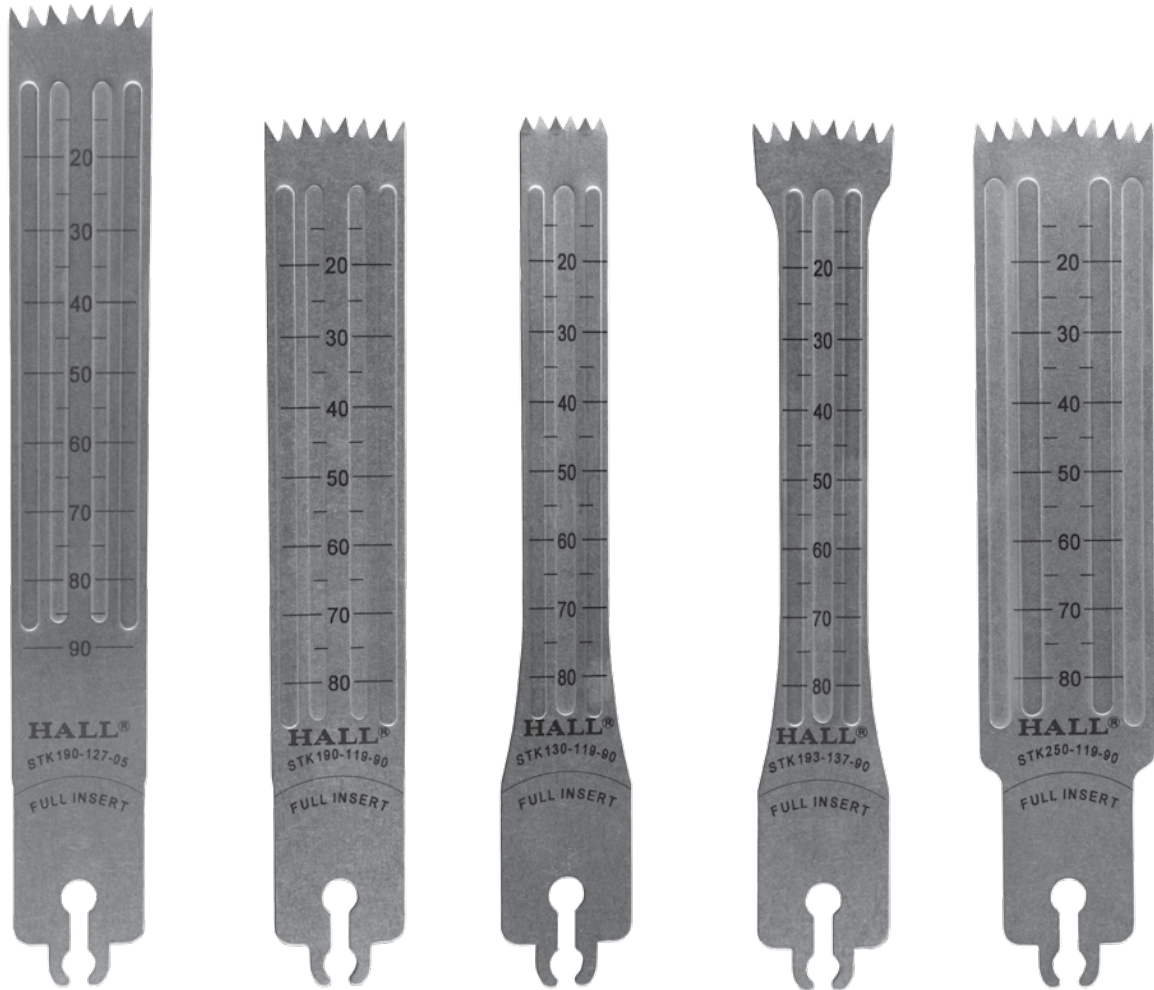

Blades images are 1:1 in length and width.

| | | | | | |
|------------------|------------------------|---------------|---------------|---------------|---------------|
| Body Width | 19.0mm | 19.0mm | 13.0mm | 19.0/13.0mm | 25.0mm |
| Length | 105.0mm | 90.0mm | 90.0mm | 90.0mm | 90.0mm |
| Thickness | Blade Catalog # | | | | |
| 0.89mm | | STK190-089-90 | STK130-089-90 | | STK193-137-90 |
| 1.00mm | | | | | STK250-100-90 |
| 1.07mm | | | | | |
| 1.19mm | | STK190-089-90 | STK130-119-90 | | STK250-119-90 |
| 1.27mm | STK190-127-05 | STK190-127-90 | STK130-127-90 | | STK250-127-90 |
| 1.37mm | | STK190-137-90 | | STK193-137-90 | STK250-137-90 |
| 1.47mm | | | | | STK250-147-90 |

All products may not be available in all markets.

Hall® Blades

| Thickness: 0.60mm | | | | | |
|-------------------|------------|-------------|-------------------------|--------------------|--|
| Cat. No. | Width (mm) | Length (mm) | Material Thickness (mm) | Cut Thickness (mm) | |
| 5071-650 | 49.00 | 63.00 | 0.60 | 0.60 | |
| Thickness: 0.64mm | | | | | |
| 5071-594 | 29.46 | 58.70 | 0.64 | 0.64 | |
| 5271-502 | 29.00 | 74.00 | 0.64 | 0.64 | |
| Thickness: 0.89mm | | | | | |
| 5071-528 | 25.00 | 73.00 | 0.89 | 0.89 | |
| 5071-533 | 21.00 | 84.50 | 0.89 | 0.89 | |
| 5071-583 | 12.70 | 90.00 | 0.89 | 0.89 | |

Products shown at actual size. All products may not be available in all markets.

Large Bone Knee Blades

Indication for Use: Total Knee Arthroplasty



Hall® Blades

| | | | | | Thickness: 0.89mm |
|----------|------------|-------------|-------------------------|--------------------|-------------------|
| Cat. No. | Width (mm) | Length (mm) | Material Thickness (mm) | Cut Thickness (mm) | |
| 5071-589 | 13.00 | 90.00 | 0.89 | 0.89 | |
| | | | | | Thickness: 0.90mm |
| 5071-532 | 12.00 | 80.00 | 0.90 | 0.90 | |
| 5071-185 | 19.50 | 80.00 | 0.90 | 0.90 | |
| 5071-195 | 19.50 | 80.00 | 0.90 | 0.90 | |
| 5071-146 | 25.40 | 90.00 | 0.90 | 0.90 | |
| 5071-196 | 25.40 | 90.00 | 0.90 | 0.90 | |
| 5071-120 | 19.50 | 95.00 | 0.90 | 0.90 | |

Grey shaded blades indicate coating.
Products shown at actual size.

Hall® Blades

| | | | | | Thickness: 0.90mm |
|----------|------------|-------------|-------------------------|--------------------|-------------------|
| Cat. No. | Width (mm) | Length (mm) | Material Thickness (mm) | Cut Thickness (mm) | |
| 5071-121 | 25.40 | 95.00 | 0.90 | 0.90 | |
| | | | | | Thickness: 1.00mm |
| 5071-562 | 25.40 | 90.00 | 1.00 | 1.00 | |
| 5071-538 | 25.40 | 95.00 | 1.00 | 1.00 | |
| | | | | | Thickness: 1.19mm |
| 5071-548 | 12.70 | 86.00 | 1.19 | 1.19 | |
| 5071-547 | 25.40 | 86.00 | 1.19 | 1.19 | |
| | | | | | Thickness: 1.20mm |
| 5071-167 | 19.50 | 90.00 | 1.20 | 1.20 | |
| 5071-184 | 19.50 | 90.00 | 1.20 | 1.20 | |

Grey shaded blades indicate coating. Products shown at actual size. All products may not be available in all markets.

Large Bone Knee Blades

Indication for Use: Total Knee Arthroplasty



Hall® Blades

| | | | | | Thickness: 1.24mm | |
|-------------|------------|-------------|-------------------------|--------------------|-------------------|--|
| Cat. No. | Width (mm) | Length (mm) | Material Thickness (mm) | Cut Thickness (mm) | | |
| 5071-558 | 18.50 | 73.00 | 1.24 | 1.24 | | |
| 5071-534 | 25.40 | 79.50 | 1.24 | 1.24 | | |
| 5071-570-50 | 25.00 | 95.00 | 1.24 | 1.24 | | |
| 5071-526 | 18.50 | 107.00 | 1.24 | 1.24 | | |
| | | | | | Thickness: 1.26mm | |
| 5071-573 | 18.50 | 90.00 | 1.26 | 1.26 | | |
| 5071-575 | 31.00 | 90.00 | 1.26 | 1.26 | | |

Products shown at actual size.

Hall® Blades

| | | | | | Thickness: 1.27mm |
|----------|------------|-------------|-------------------------|--------------------|-------------------|
| Cat. No. | Width (mm) | Length (mm) | Material Thickness (mm) | Cut Thickness (mm) | |
| 5071-527 | 19.00 | 80.00 | 1.27 | 1.27 | |
| 5071-180 | 10.00 | 85.00 | 1.27 | 1.27 | |
| 5271-580 | 10.00 | 85.00 | 1.27 | 1.27 | |
| 5071-531 | 25.40 | 85.00 | 1.27 | 1.27 | |
| 5071-181 | 19.50 | 86.00 | 1.27 | 1.27 | |
| 5071-201 | 19.50 | 86.00 | 1.27 | 1.27 | |
| 5071-582 | 13.00 | 90.00 | 1.27 | 1.27 | |

Grey shaded blades indicate coating.
Products shown at actual size.

All products may not be available in all markets.

Large Bone Knee Blades

Indication for Use: Total Knee Arthroplasty



Hall® Blades

| | | | | | Thickness: 1.27mm | |
|----------|------------|-------------|-------------------------|--------------------|-------------------|--|
| Cat. No. | Width (mm) | Length (mm) | Material Thickness (mm) | Cut Thickness (mm) | | |
| 5071-161 | 25.40 | 90.00 | 1.27 | 1.27 | | |
| 5071-564 | 25.40 | 90.00 | 1.27 | 1.27 | | |
| 5271-561 | 25.40 | 90.00 | 1.27 | 1.27 | | |
| 5071-590 | 13.00 | 95.00 | 1.27 | 1.27 | | |
| 5071-568 | 16.50 | 95.00 | 1.27 | 1.27 | | |
| 5071-576 | 16.50 | 95.00 | 1.27 | 1.27 | | |
| 5071-123 | 19.50 | 95.00 | 1.27 | 1.27 | | |

Products shown at actual size.

Hall® Blades

| | | | | | Thickness: 1.27mm |
|----------|------------|-------------|-------------------------|--------------------|-------------------|
| Cat. No. | Width (mm) | Length (mm) | Material Thickness (mm) | Cut Thickness (mm) | |
| 5071-519 | 21.00 | 95.00 | 1.27 | 1.27 | |
| 5071-124 | 25.40 | 95.00 | 1.27 | 1.27 | |
| 5071-129 | 19.50 | 105.00 | 1.27 | 1.27 | |
| 5071-529 | 19.50 | 105.00 | 1.27 | 1.27 | |

Products shown at actual size.

Large Bone Knee Blades

Indication for Use: Total Knee Arthroplasty



Hall® Blades

| | | | | | Thickness: 1.37mm |
|----------|------------|-------------|-------------------------|--------------------|-------------------|
| Cat. No. | Width (mm) | Length (mm) | Material Thickness (mm) | Cut Thickness (mm) | |
| 5071-163 | 25.40 | 90.00 | 1.37 | 1.37 | |
| 5071-525 | 19.00 | 95.00 | 1.37 | 1.37 | |
| 5071-530 | 19.00 | 95.00 | 1.37 | 1.37 | |
| 5071-539 | 25.40 | 95.00 | 1.37 | 1.37 | |
| | | | | | Thickness: 1.47mm |
| 5071-565 | 25.40 | 90.00 | 1.47 | 1.47 | |
| | | | | | Thickness: 1.50mm |
| 5071-144 | 25.40 | 90.00 | 1.50 | 1.50 | |

Grey shaded blades indicate coating.
Products shown at actual size.

Stryker Blades

For use with: System 2000, System 4 & 5

| Thickness: 0.64mm | | | | | |
|-------------------|------------|-------------|-------------------------|--------------------|--|
| Cat. No. | Width (mm) | Length (mm) | Material Thickness (mm) | Cut Thickness (mm) | |
| 5072-145 | 9.12 | 25.22 | 0.64 | 0.64 | |
| 5072-140 | 29.46 | 58.70 | 0.64 | 0.64 | |
| 5072-100 | 25.00 | 73.79 | 0.64 | 0.64 | |
| 5072-150 | 12.50 | 73.80 | 0.64 | 0.64 | |
| Thickness: 0.80mm | | | | | |
| 5072-143 | 25.40 | 90.00 | 0.80 | 0.80 | |

Products shown at actual size.

Large Bone Knee Blades

Indication for Use: Total Knee Arthroplasty



Stryker Blades

For use with: System 2000, System 4 & 5

| | | | | | Thickness: 0.89mm |
|----------|------------|-------------|-------------------------|--------------------|-------------------|
| Cat. No. | Width (mm) | Length (mm) | Material Thickness (mm) | Cut Thickness (mm) | |
| 5072-105 | 24.82 | 73.79 | 0.89 | 0.89 | |
| 5072-109 | 20.70 | 85.04 | 0.89 | 0.89 | |
| 5072-102 | 24.82 | 90.47 | 0.89 | 0.89 | |
| | | | | | Thickness: 0.90mm |
| 5072-195 | 19.50 | 80.00 | 0.90 | 0.90 | |
| | | | | | Thickness: 1.20mm |
| 5072-152 | 12.50 | 82.18 | 1.20 | 1.20 | |
| 5072-151 | 25.00 | 85.67 | 1.20 | 1.20 | |
| 5072-142 | 25.40 | 90.00 | 1.20 | 1.20 | |

Grey shaded blades indicate coating.
Products shown at actual size.

Stryker Blades

For use with: System 2000, System 4 & 5

| | | | | | Thickness: 1.24mm |
|----------|------------|-------------|-------------------------|--------------------|-------------------|
| Cat. No. | Width (mm) | Length (mm) | Material Thickness (mm) | Cut Thickness (mm) | |
| 5072-218 | 25.00 | 98.50 | 1.24 | 1.24 | |
| 5072-185 | 18.50 | 104.00 | 1.24 | 1.24 | |
| | | | | | Thickness: 1.27mm |
| 5072-110 | 24.82 | 73.79 | 1.27 | 1.27 | |
| 5072-111 | 24.82 | 80.14 | 1.27 | 1.27 | |
| 5072-158 | 12.50 | 82.20 | 1.27 | 1.27 | |
| 5072-183 | 29.00 | 84.47 | 1.27 | 1.27 | |
| 5072-101 | 19.50 | 86.00 | 1.27 | 1.27 | |
| 5072-181 | 19.50 | 86.00 | 1.27 | 1.27 | |

Grey shaded blades indicate coating.
 Products shown at actual size. All products may not be available in all markets.

Large Bone Knee Blades

Indication for Use: Total Knee Arthroplasty









Stryker Blades

For use with: System 2000, System 4 & 5

| | | | | | Thickness: 1.37mm |
|----------|------------|-------------|-------------------------|--------------------|-------------------|
| Cat. No. | Width (mm) | Length (mm) | Material Thickness (mm) | Cut Thickness (mm) | |
| 5072-177 | 25.00 | 82.42 | 1.37 | 1.37 | |
| | | | | | Thickness: 1.50mm |
| 5072-176 | 25.00 | 80.14 | 1.50 | 1.50 | |

Products shown at actual size.

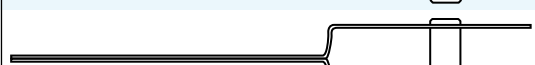
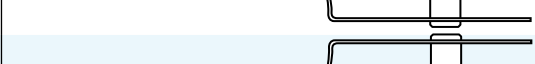
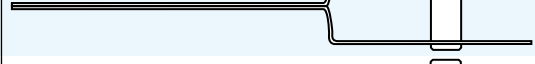
Graft Harvesting Blades

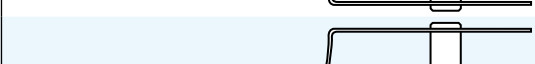
| Cat. No. | Depth Stop (mm) | Width (mm) | Material Thickness (mm) | Cut Thickness (mm) | | |
|----------|-----------------|------------|-------------------------|--------------------|---|------|
| 5071-105 | 20.00 | 16.50 | 0.40 | 5.00 |  | 5mm |
| 5071-106 | 20.00 | 16.50 | 0.40 | 6.00 |  | 6mm |
| 5071-107 | 20.00 | 16.50 | 0.40 | 7.00 |  | 7mm |
| 5071-108 | 20.00 | 16.50 | 0.40 | 8.00 |  | 8mm |
| 5071-109 | 20.00 | 16.50 | 0.40 | 9.00 |  | 9mm |
| 5071-110 | 20.00 | 16.50 | 0.40 | 10.00 |  | 10mm |
| 5071-111 | 20.00 | 16.50 | 0.40 | 11.00 |  | 11mm |
| 5071-112 | 20.00 | 16.50 | 0.40 | 12.00 |  | 12mm |
| 5071-113 | 20.00 | 16.50 | 0.40 | 13.00 |  | 13mm |

Products shown at actual size.

Large Bone Oscillating Blades

ACL Blades



ACL Blades

| Thickness: 0.60mm | | | | | |
|-------------------|------------|-------------|-------------------------|--------------------|--|
| Cat. No. | Width (mm) | Length (mm) | Material Thickness (mm) | Cut Thickness (mm) | |
| 5071-133 | 9.50 | 25.50 | 0.40 | 0.60 | |
| 5071-134 | 9.00 | 41.00 | 0.40 | 0.60 | |
| Thickness: 0.64mm | | | | | |
| 5071-236 | 9.12 | 25.22 | 0.64 | 0.64 | |
| Thickness: 0.80mm | | | | | |
| 5071-127 | 8.50 | 38.00 | 0.40 | 0.80 | |
| 5071-246 | 5.50 | 25.50 | 0.60 | 0.80 | |

Products shown at actual size.

ACL Blades

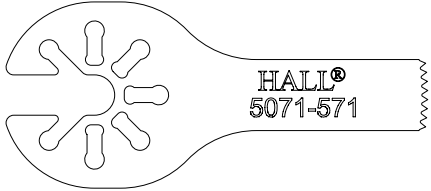
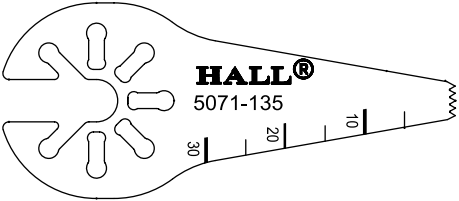
| Thickness: 0.84mm | | | | | |
|-------------------|------------|-------------|-------------------------|--------------------|---|
| Cat. No. | Width (mm) | Length (mm) | Material Thickness (mm) | Cut Thickness (mm) | |
| 5071-571 | 9.50 | 30.00 | 0.64 | 0.84 |  <p>HALL® 5071-571</p> |
| Thickness: 1.10mm | | | | | |
| 5071-135 | 5.00 | 30.00 | 0.60 | 1.10 |  <p>HALL® 5071-135</p> |

Products shown at actual size.

Large Bone Oscillating Blades

Indications for Use: Total Hip Arthroplasty
& Large Bone Trauma



Oscillating Blades

| | | | | | Thickness: 0.80mm |
|----------|------------|-------------|-------------------------|--------------------|-------------------|
| Cat. No. | Width (mm) | Length (mm) | Material Thickness (mm) | Cut Thickness (mm) | |
| 5071-132 | 19.50 | 41.00 | 0.40 | 0.80 | |
| | | | | | Thickness: 0.90mm |
| 5071-553 | 19.50 | 63.00 | 0.60 | 0.90 | |
| 5071-551 | 32.50 | 63.00 | 0.60 | 0.90 | |
| 5071-550 | 49.00 | 63.00 | 0.60 | 0.90 | |
| 5071-552 | 13.50 | 64.00 | 0.60 | 0.90 | |
| 5071-166 | 32.00 | 64.00 | 0.80 | 0.90 | |

All products may not be available in all markets.

Grey shaded blades indicate coating.
Products shown at actual size.

Oscillating Blades

| | | | | | Thickness: 0.90mm |
|----------|------------|-------------|-------------------------|--------------------|-------------------|
| Cat. No. | Width (mm) | Length (mm) | Material Thickness (mm) | Cut Thickness (mm) | |
| 5071-186 | 32.00 | 64.00 | 0.80 | 0.90 | |
| 5071-556 | 33.50 | 64.00 | 0.80 | 0.90 | |
| 5071-177 | 19.50 | 71.00 | 0.80 | 0.90 | |
| 5071-187 | 19.50 | 71.00 | 0.80 | 0.90 | |
| 5071-572 | 19.50 | 71.00 | 0.80 | 0.90 | |
| 5071-178 | 19.50 | 80.00 | 0.80 | 0.90 | |
| 5071-188 | 19.50 | 80.00 | 0.80 | 0.90 | |

Grey shaded blades indicate coating.
Products shown at actual size. All products may not be available in all markets.

Large Bone Oscillating Blades

Indications for Use: Total Hip Arthroplasty
& Large Bone Trauma



Oscillating Blades

| | | | | | Thickness: 0.90mm |
|----------|------------|-------------|-------------------------|--------------------|-------------------|
| Cat. No. | Width (mm) | Length (mm) | Material Thickness (mm) | Cut Thickness (mm) | |
| 5071-174 | 19.50 | 86.00 | 0.80 | 0.90 | |
| 5071-143 | 25.40 | 90.00 | 0.80 | 0.90 | |
| | | | | | Thickness: 1.00mm |
| 5071-560 | 25.40 | 95.00 | 0.86 | 1.00 | |
| | | | | | Thickness: 1.06mm |
| 5071-557 | 12.50 | 73.80 | 0.63 | 1.06 | |
| | | | | | Thickness: 1.40mm |
| 5071-554 | 19.50 | 71.00 | 1.20 | 1.40 | |
| 5071-141 | 19.50 | 80.00 | 1.20 | 1.40 | |

Grey shaded blades indicate coating.
Products shown at actual size.

Oscillating Blades

| | | | | | Thickness: 1.40mm | |
|----------|------------|-------------|-------------------------|--------------------|-------------------|--|
| Cat. No. | Width (mm) | Length (mm) | Material Thickness (mm) | Cut Thickness (mm) | | |
| 5071-140 | 25.40 | 80.00 | 1.20 | 1.40 | | |
| 5071-142 | 25.40 | 90.00 | 1.20 | 1.40 | | |
| | | | | | Thickness: 1.50mm | |
| 5071-555 | 33.00 | 71.00 | 1.20 | 1.50 | | |
| 5071-145 | 13.00 | 72.00 | 1.20 | 1.50 | | |

Oscillating Abrader

| Cat. No. | Width (mm) | Length (mm) | |
|----------|------------|-------------|--|
| 5071-175 | 20.00 | 45.70 | |

Grey shaded blades indicate coating.
Products shown at actual size.

All products may not be available in all markets.

Large Bone Reciprocating Blades

Indications for Use: Total Joint Arthroplasty
& Large Bone Trauma





Hall® Reciprocating Blades

| | | | | | Thickness: 0.60mm |
|----------|------------|-------------|-------------------------|--------------------|-------------------|
| Cat. No. | Width (mm) | Length (mm) | Material Thickness (mm) | Cut Thickness (mm) | |
| 5052-260 | 12.50 | 38.00 | 0.40 | 0.60 | |
| | | | | | Thickness: 0.90mm |
| 5052-179 | 12.50 | 76.00 | 0.90 | 0.90 | |
| | | | | | Thickness: 1.00mm |
| 5052-259 | 9.40 | 54.50 | 0.60 | 1.00 | |
| 5052-173 | 12.50 | 73.50 | 0.80 | 1.00 | |
| 5052-258 | 12.50 | 89.00 | 0.60 | 1.00 | |
| | | | | | Thickness: 1.27mm |
| 5052-291 | 12.50 | 76.00 | 1.27 | 1.27 | |
| | | | | | Thickness: 1.50mm |
| 5052-276 | 13.00 | 48.00 | 1.50 | 1.50 | |
| 5052-281 | 9.40 | 54.50 | 1.50 | 1.50 | |
| | | | | | Thickness: 1.60mm |
| 5052-261 | 12.50 | 89.00 | 1.50 | 1.60 | |

Grey shaded blades indicate coating.
Products shown at actual size.

Stryker Reciprocating Blades

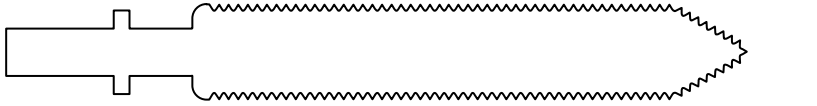
For use with: System 2000, System 4 & 5

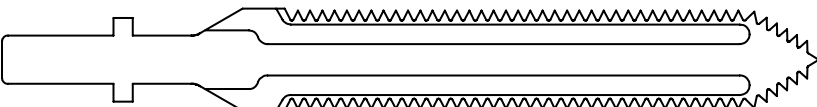
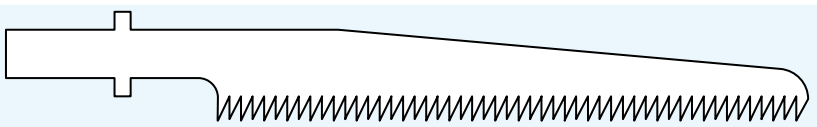
| Cat. No. | Width (mm) | Length (mm) | Material Thickness (mm) | Cut Thickness (mm) | |
|----------|------------|-------------|-------------------------|--------------------|--|
| 5052-334 | 12.50 | 73.50 | 0.60 | 0.60 |  |
| 5052-332 | 12.00 | 76.00 | 0.80 | 0.80 |  |
| 5052-135 | 12.50 | 76.00 | 0.90 | 0.90 |  |
| 5052-333 | 12.00 | 76.00 | 1.30 | 1.30 |  |

Products shown at actual size.

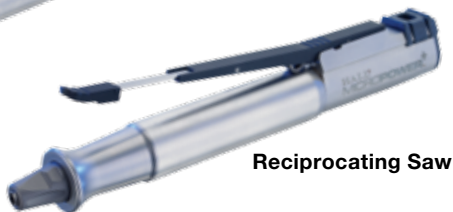
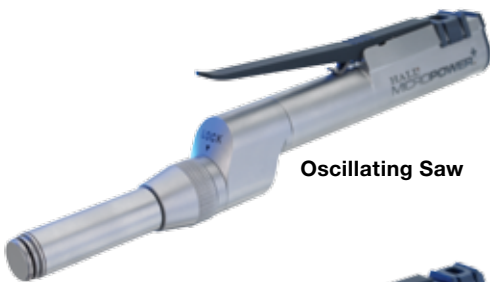
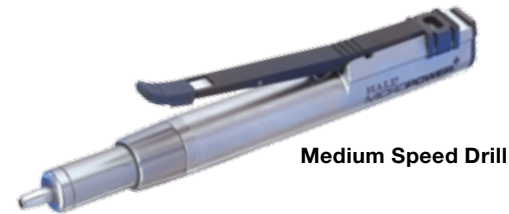

Attachments on page 43

Handpieces

Removable Lever

Oral Max Elite High Speed Drill.....PRO7000DE

Orthopedic High Speed Drill.....PRO7000SE

Medium Speed Drill.....PRO7100SE

Sagittal Saw.....PRO7200SE

Oscillating Saw.....PRO7300SE

Reciprocating Saw.....PRO7400SE

Attachments on page 43

Handpieces

| | Removable Lever | Permanently Attached Lever |
|----------------------------------|-----------------|----------------------------|
| Oral Max High Speed Drill..... | 6020-025 | 6021-025 |
| Orthopedic High Speed Drill..... | 6020-026 | 6021-026 |
| Medium Speed Drill..... | 6020-021 | 6021-021 |
| Sagittal Saw..... | 6020-022 | 6021-022 |
| Reciprocating Saw..... | 6020-023 | 6021-023 |
| Oscillating Saw..... | 6020-024 | 6021-024 |



Oral Max™ High Speed Drill



Orthopedic High Speed Drill

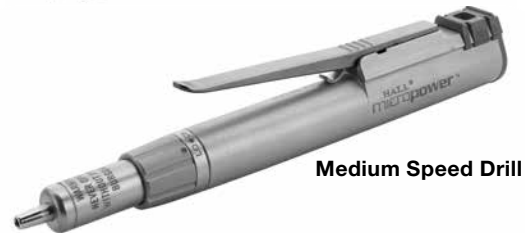

Medium Speed Drill



Sagittal Saw

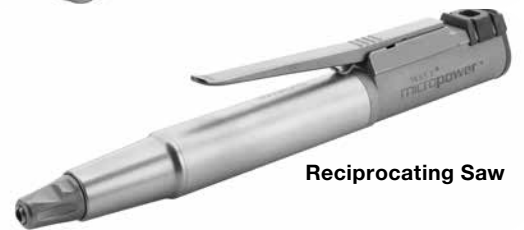

Reciprocating Saw



Oscillating Saw

All products may not be available in all markets.

Micro 100™

Indications for Use: Small Bone



Attachments on Page 43

Handpieces

| | Cat. No. |
|---|----------|
| Surgairtome Two® High Speed Drill Kit (System listing on page 83) | 5058-000 |
| Surgairtome Two High Speed Drill | 5058-001 |
| Medium Speed Drill | 5053-009 |
| Reciprocating Saw | 5053-010 |
| Sagittal Saw | 5053-011 |
| Oscillating Saw | 5053-012 |
| XL Oscillating Saw | 5053-022 |
| Wire Driver | 5053-013 |
| Throttle Clip (for lever) Used during footswitch operation | 5053-074 |

Attachments & Accessories

| | |
|--|----------|
| Wire Guard for use with 5053-013 | 5053-123 |
| Wire Driver Adapter Chuck for use with 5053-013 | 5053-019 |
| Replacement Hex Wrench for Micro 100™ Sagittal & Oscillating Saw | 1365-005 |
| Burguard Sleeve Surgairtome Two | 1375-112 |
| Smartguard® | 5020-160 |
| Smartguard Irrigator | 6020-260 |

All products may not be available in all markets.

Attachments

| | Cat. No. |
|---|-----------|
| Medium Precision Bur Guard..... | 1375-012P |
| Long Precision Bur Guard | 1375-011P |
| X-Long Precision Bur Guard..... | 1375-023P |
| Medium Bur Guard | 1375-012 |
| Long Bur Guard..... | 1375-011 |
| X-Long Bur Guard..... | 1375-023 |
| Laminectomy Guard..... | 1375-020 |
| Use 5092-103/203 long carbide burs, the laminectomy burs are the only burs that can be inserted prior to placing bur guard. | |
| Rhinoplasty Guard | 1375-021 |
| Tissue Retractor | 1387-022 |
| Use only with long burs (5092 series) which have diameter of 4.0mm or less. Recommended burs 5092-136. | |
| 20 degree Angled Attachment | 1375-032 |
| Use only 5092 series X-long burs. | |
| 20 degree X-Long Angled Attachment..... | 1375-033 |
| Use only 5093 series X-long burs. | |
| 70 degree Contra Angle with Dental Head..... | 1375-034 |
| Use friction grip burs only – size .0625" or 1.58mm diameter. Not available from ConMed. | |
| 70 degree Contra Angle with Surgical Head | 1375-035 |
| Use only 5089 ultra-short burs and 5090 series short burs. | |
| 90 degree Angled Attachment | 1375-036 |
| Use only 5089 X-short burs and 5090 series short burs. | |
| Bur Changer for 70 and 90 degree Angled Attachments | 1375-003 |
| Irrigation Tubing Set..... | E9418 |

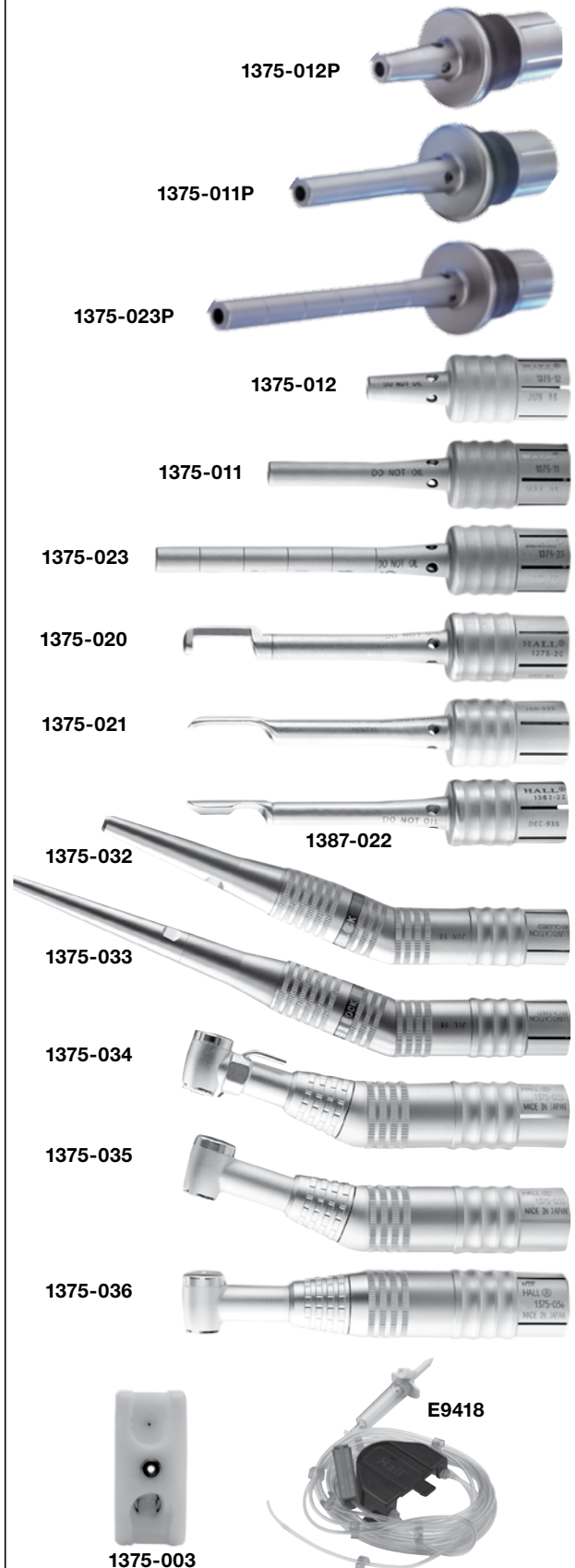

All products may not be available in all markets.

Sterilization Trays

For Use with Micro Handpieces



Hall 50™ Sterilization Containers

Cat. No.

½ Size Rigid Sterilization ContainerTR12R

Sterilization Inner Trays

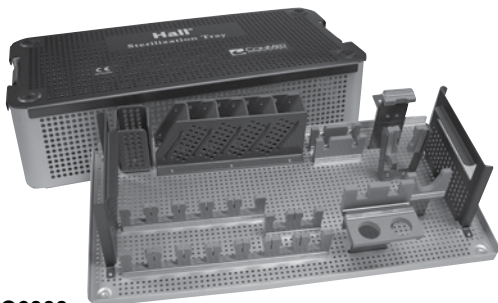

½ Size Inner Tray, Small Bone Set.....PR07003T



PRO6000

Small Bone TrayPR06000

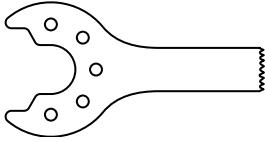
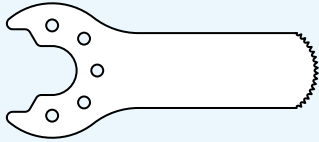
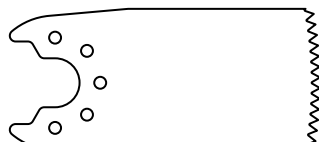
Sagittal Saw Blades

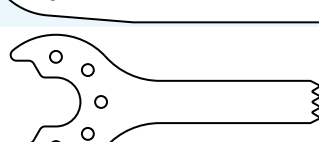
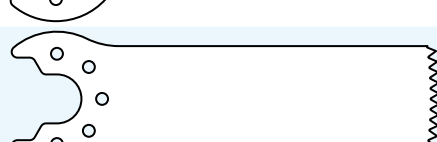
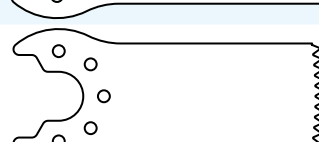
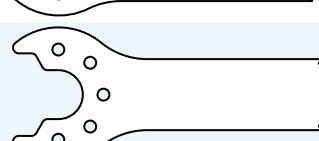
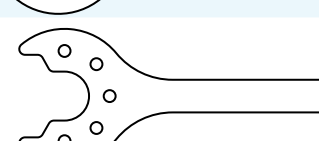
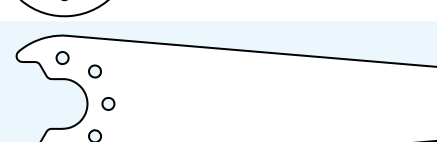
| Thickness: 0.60mm | | | | | | |
|-------------------|--------------|------------|-------------|-------------------------|--------------------|---|
| Cat. No. | Tooth | Width (mm) | Length (mm) | Material Thickness (mm) | Cut Thickness (mm) | |
| 5023-144 | Fine | 5.50 | 18.50 | 0.40 | 0.60 |  |
| 5023-118 | Fine | 9.50 | 25.50 | 0.40 | 0.60 |  |
| 5023-130 | Coarse | 19.50 | 25.50 | 0.40 | 0.60 |  |
| 5023-131 | Coarse | 19.50 | 41.00 | 0.40 | 0.60 |  |
| 5023-132 | Coarse | 5.50 | 25.50 | 0.40 | 0.60 |  |
| 5023-133 | Coarse | 14.00 | 41.00 | 0.40 | 0.60 |  |
| 5023-137 | Coarse | 14.00 | 25.50 | 0.40 | 0.60 |  |
| 5023-138 | Fine | 9.50 | 25.50 | 0.40 | 0.60 |  |
| 5023-139 | Fine | 4.50 | 25.50 | 0.40 | 0.60 |  |
| 5023-140 | Tapered/Fine | 9.50 | 41.00 | 0.40 | 0.60 |  |

Products shown at actual size.
All products may not be available in all markets.

Micro Sagittal Saw Blades



Sagittal Saw Blades

| Thickness: 0.60mm | | | | | | |
|-------------------|--------|------------|-------------|-------------------------|--------------------|--|
| Cat. No. | Tooth | Width (mm) | Length (mm) | Material Thickness (mm) | Cut Thickness (mm) | |
| 5023-141 | Fine | 6.00 | 34.00 | 0.40 | 0.60 | |
| 5023-142 | Fine | 4.00 | 34.00 | 0.40 | 0.60 | |
| 5023-143 | Coarse | 9.50 | 25.50 | 0.40 | 0.60 | |
| 5023-244 | Fine | 4.00 | 6.00 | 0.40 | 0.60 | |
| 5044-145 | Fine | 10.00 | 18.50 | 0.40 | 0.60 | |
| 5023-247 | Fine | 9.50 | 25.50 | 0.60 | 0.60 | |
| 5023-249 | Fine | 9.00 | 31.00 | 0.40 | 0.60 | |

Products shown at actual size.

Angled Sagittal Saw Blades

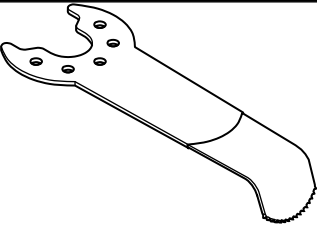
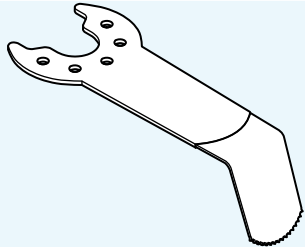
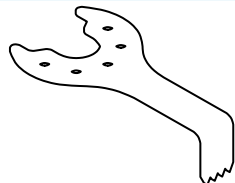
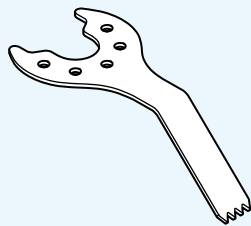
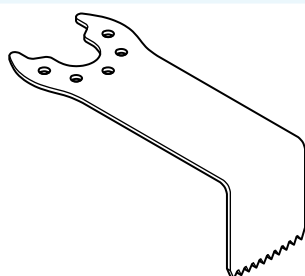
| | | | | | | | Thickness: 0.60mm | |
|----------|--------|-----------|------------|-------------|-------------------------|--------------------|---|--|
| Cat. No. | Tooth | Angle | Width (mm) | Length (mm) | Material Thickness (mm) | Cut Thickness (mm) | | |
| 5023-128 | Fine | 70 Degree | 9.50 | 7.50 | 0.40 | 0.60 |  | |
| 5023-129 | Fine | 70 Degree | 9.50 | 13.50 | 0.40 | 0.60 |  | |
| 5023-134 | Coarse | 90 Degree | 5.50 | 9.00 | 0.40 | 0.60 |  | |
| 5023-135 | Coarse | 45 Degree | 5.50 | 18.00 | 0.40 | 0.60 |  | |
| 5023-136 | Coarse | 90 Degree | 14.00 | 15.50 | 0.40 | 0.60 |  | |

Products shown at actual size.

All products may not be available in all markets.

Micro Sagittal Saw Blades



ACL Blades

| Thickness: 0.60mm | | | | | | | | |
|-------------------|----------------|----------|---------------------------------|------------|-------------|-------------------------|--------------------|--|
| Cat. No. | Tooth | Edge | Depth Stop (mm) | Width (mm) | Length (mm) | Material Thickness (mm) | Cut Thickness (mm) | |
| C8803 | Fine | Straight | 8.0 with guide/12 without guide | 9.40 | 41.00 | 0.38 | 0.60 | |
| C8804 | Fine | Straight | 8.0 Freehand | 9.40 | 41.00 | 0.38 | 0.60 | |
| C8806 | Fine | Straight | 10.0 Freehand | 9.40 | 41.00 | 0.38 | 0.60 | |
| 8703 | Fine | Straight | 8.0 with guide/12 without guide | 9.50 | 25.50 | 0.40 | 0.60 | |
| 5023-183 | Fine | Straight | None | 9.50 | 25.50 | 0.40 | 0.60 | |
| 5023-184 | Tapered/Fine | Straight | None | 9.50 | 41.00 | 0.40 | 0.60 | |
| 5023-185 | Tapered/Coarse | Straight | None | 6.50 | 30.00 | 0.40 | 0.60 | |
| Thickness: 0.69mm | | | | | | | | |
| 5023-182 | Coarse | Straight | None | 19.00 | 41.00 | 0.40 | 0.69 | |
| Thickness: 0.74mm | | | | | | | | |
| 5023-186 | Coarse | Straight | None | 8.50 | 38.00 | 0.40 | 0.74 | |

Products shown at actual size.

Dermabraders

| Thickness: 3.80mm | | | | | | |
|-------------------|---------|-----------|------------|-------------|-------------------------|--|
| Cat. No. | Tooth | Edge | Width (mm) | Length (mm) | Material Thickness (mm) | |
| 5023-055 | Abrader | Straight | 25.00 | 6.30 | 3.80 | |
| 5023-056 | Abrader | 25 Degree | 25.00 | 6.30 | 3.80 | |
| 5023-057 | Abrader | 70 Degree | 25.00 | 6.30 | 3.80 | |

Graft Harvesting Blades

| Cat. No. | Depth Stop (mm) | Width (mm) | Material Thickness (mm) | Cut Thickness (mm) | |
|----------|-----------------|------------|-------------------------|--------------------|--|
| 5023-405 | 20.00 | 16.50 | 0.40 | 5.00 | |
| 5023-406 | 20.00 | 16.50 | 0.40 | 6.00 | |
| 5023-407 | 20.00 | 16.50 | 0.40 | 7.00 | |
| 5023-408 | 20.00 | 16.50 | 0.40 | 8.00 | |
| 5023-409 | 20.00 | 16.50 | 0.40 | 9.00 | |
| 5023-410 | 20.00 | 16.50 | 0.40 | 10.00 | |
| 5023-411 | 20.00 | 16.50 | 0.40 | 11.00 | |
| 5023-412 | 20.00 | 16.50 | 0.40 | 12.00 | |
| 5023-413 | 20.00 | 16.50 | 0.40 | 13.00 | |

Products shown at actual size.

All products may not be available in all markets.

Micro Oscillating Saw Blades



Oscillating Saw Blades

| Thickness: 0.60mm | | | | | | | |
|-------------------|-------|----------|------------|-------------|-------------------------|--------------------|--|
| Cat. No. | Tooth | Edge | Width (mm) | Length (mm) | Material Thickness (mm) | Cut Thickness (mm) | |
| 5023-160 | Fine | Straight | 5.50 | 12.00 | 0.40 | 0.60 | |
| 5023-161 | Fine | Straight | 10.00 | 12.00 | 0.40 | 0.60 | |
| 5023-162 | Fine | Straight | 5.50 | 18.50 | 0.40 | 0.60 | |
| 5023-163 | Fine | Straight | 10.00 | 18.50 | 0.40 | 0.60 | |
| 5023-164 | Fine | Straight | 5.50 | 28.50 | 0.40 | 0.60 | |
| 5023-165 | Fine | Radial | 10.00 | 28.50 | 0.40 | 0.60 | |
| 5023-166 | Fine | Radial | 18.50 | 28.50 | 0.40 | 0.60 | |
| 5023-169 | Fine | Straight | 10.00 | 35.00 | 0.40 | 0.60 | |

Angled Oscillating Saw Blades

| Thickness: 0.60mm | | | | | | | |
|-------------------|-------|------------------|------------|-------------|-------------------------|--------------------|--|
| Cat. No. | Tooth | Edge | Width (mm) | Length (mm) | Material Thickness (mm) | Cut Thickness (mm) | |
| 5023-258 | Fine | Radial/20 Degree | 10.00 | 9.00 | 0.40 | 0.60 | |
| 5023-259 | Fine | Radial/20 Degree | 10.00 | 13.50 | 0.40 | 0.60 | |
| 5023-167 | Fine | 20 Degree | 5.50 | 13.00 | 0.40 | 0.60 | |
| 5023-168 | Fine | Radial/20 Degree | 10.00 | 13.00 | 0.40 | 0.60 | |

Products shown at actual size.

Intra-Oral Blades *Not for use with Micro 100™

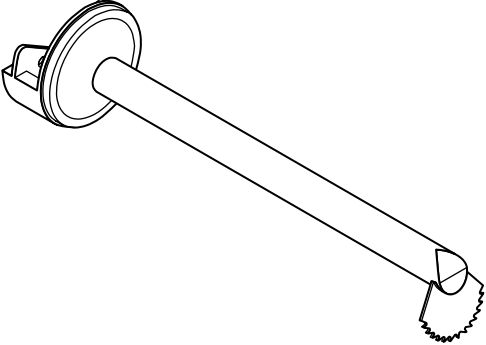
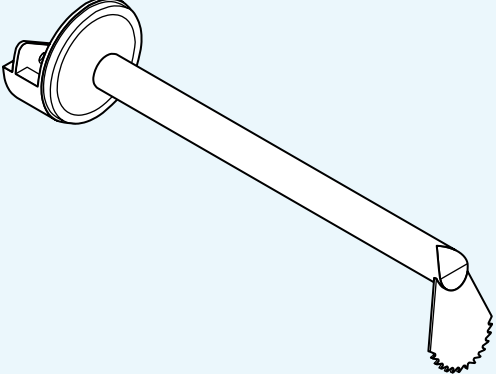
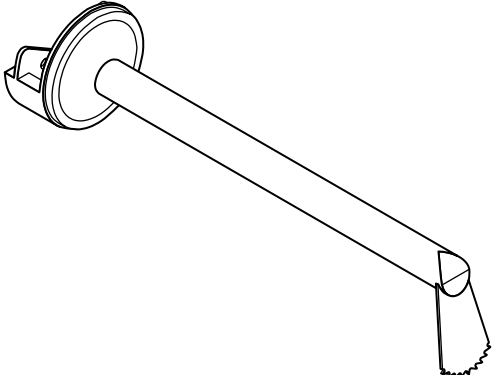
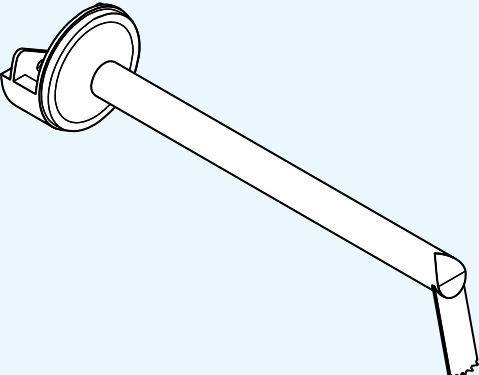
| | | | | | | | Thickness: 0.60mm | |
|-----------|--------|------------|-------------|-------------------------|--------------------|--------------------|--|--|
| Cat. No. | Tooth | Width (mm) | Length (mm) | Material Thickness (mm) | Cut Thickness (mm) | Cutting Depth (mm) | | |
| 5023-101* | Coarse | 11.50 | 7.00 | 0.40 | 0.60 | 7.00 |  | |
| 5023-102* | Coarse | 11.50 | 12.00 | 0.40 | 0.60 | 12.00 |  | |
| 5023-103* | Coarse | 9.00 | 12.00 | 0.40 | 0.60 | 12.0 |  | |
| 5023-104* | Coarse | 5.00 | 12.00 | 0.40 | 0.60 | 12.00 |  | |

Products shown at actual size. All products may not be available in all markets.

Micro Oscillating Saw Blades

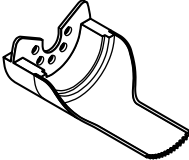
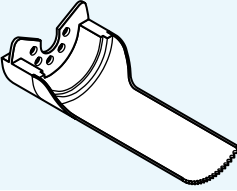
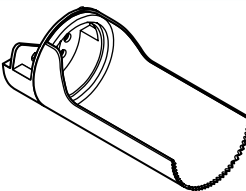
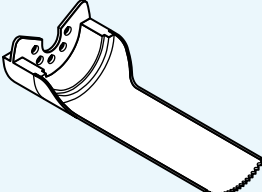

Crescentic Blades

| | | | | | | | Thickness: 0.60mm | |
|----------|-------|------------|-------------|-------------------------|--------------------|--------------------|--|--|
| Cat. No. | Tooth | Width (mm) | Length (mm) | Material Thickness (mm) | Cut Thickness (mm) | Cutting Depth (mm) | | |
| 5023-170 | Fine | 9.0 | 12.00 | 0.40 | 0.60 | 12.00 |  | |
| 5023-171 | Fine | 13.5 | 25.50 | 0.40 | 0.60 | 25.50 |  | |
| 5023-172 | Fine | 18.0 | 32.00 | 0.40 | 0.60 | 32.00 |  | |
| 5023-176 | Fine | 13.5 | 32.00 | 0.40 | 0.60 | 32.00 |  | |

Products shown at actual size.

Reciprocating Rasp

| Cat. No. | Shank | Width (mm) | Length (mm) | |
|----------|-------|------------|-------------|--|
| 5053-080 | Round | 5.50 | 9.50 | |
| 5053-082 | Round | 5.50 | 9.50 | |
| 5053-081 | Round | 6.50 | 12.50 | |
| 5053-083 | Round | 6.50 | 12.50 | |
| 5053-084 | Round | 5.30 | 24.50 | |
| 5053-085 | Round | 9.50 | 30.50 | |

Reciprocating Saw Blades

| Cat. No. | Shank | Length (mm) | Material Thickness (mm) | |
|----------|-------|-------------|-------------------------|--|
| 5053-122 | Flat | 25.50 | 0.25 | |
| 5053-220 | Flat | 25.50 | 0.40 | |
| 5053-221 | Flat | 38.00 | 0.40 | |
| 5053-054 | Round | 25.00 | 0.60 | |
| 5053-126 | Round | 28.00 | 0.60 | |

Depth Limiting Reciprocating Saw Blades

| Thickness: 4.00mm | | | | | |
|-------------------|-------|-------------|-------------------------|----------------|--|
| Cat. No. | Shank | Length (mm) | Material Thickness (mm) | Cut Depth (mm) | |
| 5053-051 | Round | 17.00 | 0.60 | 4.00 | |
| Thickness: 5.00mm | | | | | |
| 5053-050 | Round | 7.00 | 0.60 | 5.00 | |
| 5053-052 | Round | 23.00 | 0.60 | 5.00 | |
| Thickness: 7.00mm | | | | | |
| 5053-053 | Round | 25.00 | 0.60 | 7.00 | |

Products shown at actual size.
All products may not be available in all markets.

Micro Burs



| MicroPower & Micro 100 Bur Guards | Round Fluted | | | | | | | | | | | | |
|-----------------------------------|---------------|----------|----------|----------|----------|----------|----------|----------|----------|----------|----------|-------|----------|
| | Flutes (mm) | 4.00 | 6.00 | 6.00 | 8.00 | 6.00 | 8.00 | 6.00 | 8.00 | 8.00 | 10.00 | 10.00 | 10.00 |
| | Diameter (mm) | 0.50 | 1.00 | 1.50 | 1.80 | 2.00 | 2.30 | 2.40 | 3.00 | 4.00 | 5.00 | 6.00 | 6.50 |
| 1375-012 | | | | 5091-222 | 5091-221 | 5091-224 | 5091-223 | 5091-225 | 5091-226 | 5091-228 | 5091-230 | M60R | 5091-232 |
| 1375-011 | | | 5092-220 | 5092-222 | L18R | 5092-224 | L23R | | 5092-226 | 5092-228 | 5092-230 | L60R | 5092-232 |
| 1375-023 | | 5093-221 | 5093-220 | | | 5093-224 | | | 5093-226 | 5093-228 | 5093-230 | X60R | 5093-232 |
| 1387-022 | | | | | | | | | 5092-236 | | | | |

| MicroPower & Micro 100 Bur Guards | Fine Round Diamond | | | | | | |
|-----------------------------------|--------------------|------|----------|----------|----------|----------|----------|
| | Diameter (mm) | 1.00 | 2.00 | 3.00 | 4.00 | 5.00 | 6.00 |
| 1375-012 | | | 5091-260 | | 5091-264 | 5091-268 | M60D |
| 1375-011 | | L10D | 5092-260 | 5092-262 | 5092-264 | 5092-266 | 5092-268 |
| 1375-023 | | X10D | 5093-260 | 5093-262 | 5093-264 | 5093-266 | |

| MicroPower & Micro 100 Bur Guards | Wire Pass Burs | | | |
|-----------------------------------|----------------|----------|----------|----------|
| | Flutes (mm) | 2.00 | 2.00 | 2.00 |
| | Diameter (mm) | 1.00 | 1.50 | 2.00 |
| | Length (mm) | 19.00 | 19.00 | 19.00 |
| 1375-035 | | 5090-247 | 5090-248 | 5090-249 |
| 1375-036 | | 5090-247 | 5090-248 | 5090-249 |
| 1375-011 | | 5092-247 | | |
| 1375-032 | | 5092-247 | | |
| 1375-012 | | 5091-247 | 5091-248 | 5091-249 |

| MicroPower & Micro 100 Bur Guards | Swanson Reamers | | | | |
|-----------------------------------|-----------------|----------|----------|----------|----------|
| | Flutes (mm) | 4.00 | 6.00 | 6.00 | 8.00 |
| | Diameter (mm) | 2.00 | 3.00 | 4.00 | 5.00 |
| 1375-012 | | 5091-242 | 5091-243 | 5091-244 | 5091-245 |

| MicroPower & Micro 100 Bur Guards | Dermabraders - Fine Diamond | | | | | N/A | N/A | N/A | N/A | |
|-----------------------------------|-----------------------------|----------|----------|----------|----------|----------|----------|----------|----------|-------|
| | Diameter (mm) | 2.00 | 4.00 | 6.00 | 4.00 | 4.00 | 7.00 | 12.00 | 10.00 | 2.00 |
| | Bur Head Length (mm) | | | | 8.00 | 15.00 | 15.00 | 15.00 | 15.00 | 19.00 |
| 1375-012 | | 5091-260 | 5091-264 | 5091-268 | 5091-270 | 5091-080 | 5091-081 | 5091-082 | 5091-083 | |
| 1375-011 | | | | | 5092-270 | | | | | |

Bur Shank Diameter 2.34mm (0.82")

Products shown at actual size.

All products may not be available in all markets.

| | | | | | | | | | | | | | | | |
|---------------------|-----------------------------------|----------------------|------|----------|------|------|----------|----------|----------|----------|------|----------|-------|------|------|
| | Straight Side Cutting Burs | | | | | | | | | | | | | | |
| | | Flutes (mm) | 6.00 | 6.00 | 6.00 | 6.00 | 6.00 | 6.00 | 6.00 | 6.00 | 6.00 | 6.00 | 6.00 | 6.00 | 6.00 |
| | | Diameter (mm) | 1.00 | 1.10 | 1.20 | 1.30 | 1.30 | 1.50 | 1.50 | 1.50 | 1.60 | 1.60 | 1.70 | 1.70 | 1.70 |
| | MicroPower & Micro 100 Bur Guards | Bur Head Length (mm) | 5.00 | 5.00 | 4.90 | 9.90 | 9.90 | 5.10 | 8.00 | 10.00 | 4.30 | 7.50 | 12.00 | 9.90 | 9.90 |
| 1375-012 | | 5091-201 | M10S | 5091-216 | | M13S | 5091-204 | | 5091-202 | 5091-217 | M15S | | | M17S | |
| 1375-011 | | | | | L13S | | 5092-204 | | | | | 5092-203 | L17S | | |
| 1375-020 | | | | | | | | | | | | 5092-203 | | | |
| 1375-035 & 1375-036 | | | | | | | | 5089-208 | | | | | | | |

| | | | | | | | | |
|----------|-----------------------------------|----------------------|------|----------|------|------|-------|----------|
| | Tapered Side-cutting | | | | | | | |
| | | Diameter (mm) | 0.80 | 1.20 | 1.20 | 1.20 | 1.60 | 1.60 |
| | MicroPower & Micro 100 Bur Guards | Bur Head Length (mm) | 4.90 | 9.90 | 3.70 | 9.90 | 21.60 | 4.30 |
| 1375-012 | | 5091-215 | M12T | 5091-219 | | | M20T | 5091-218 |
| 1375-011 | | | | | L12T | | | |

| | | | | | | | |
|----------|-----------------------------------|----------------------|-------|----------|----------|----------|----------|
| | Tapered Side-cutting | | | | | | |
| | | Diameter (mm) | 1.60 | 2.00 | 2.00 | 2.00 | 2.00 |
| | MicroPower & Micro 100 Bur Guards | Bur Head Length (mm) | 21.90 | 7.50 | 19.00 | 7.50 | 19.00 |
| 1375-012 | | | | 5091-206 | 5091-214 | | |
| 1375-011 | | | L20T | | | 5092-206 | 5092-214 |

| | | | | |
|----------|-----------------------------------|----------------------|----------|-------|
| | Barrel Burs | | | |
| | | Flutes (mm) | 6.00 | 6.00 |
| | | Diameter (mm) | 2.00 | 4.00 |
| | MicroPower & Micro 100 Bur Guards | Bur Head Length (mm) | 10.00 | 10.00 |
| 1375-012 | | 5091-252 | 5091-254 | |
| 1375-011 | | 5092-252 | 5092-254 | |

| | | | | | | |
|----------|-----------------------------------|----------------------|----------|------|------|------|
| | Oval Burs | | | | | |
| | | Flutes (mm) | 8.00 | 8.00 | 8.00 | 8.00 |
| | | Diameter (mm) | 4.00 | 5.50 | 4.00 | 5.50 |
| | MicroPower & Micro 100 Bur Guards | Bur Head Length (mm) | 8.00 | 10.0 | 7.9 | 10.0 |
| 1375-012 | | 5091-236 | 5091-238 | M40B | M55B | |
| 1375-011 | | 5092-236 | 5092-238 | L40B | L55B | |
| 1375-023 | | 5093-236 | 5093-238 | X40B | X55B | |
| 1387-022 | | 5092-236 | | | | |



Products shown at actual size.
All products may not be available in all markets.

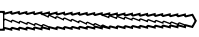

Micro Burs

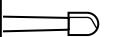

| | | |
|--|-----------------------|---|
| | Lindemann Burs |  |
| | Flutes (mm) | 4.00 |
| | Diameter (mm) | 1.60 |
| MicroPower & Micro 100 Bur Guards | Bur Head Length (mm) | 31.00 |
| 1375-012 | | 5091-212 |

| | | |
|--|----------------------|---|
| | Cylindrical |  |
| | Flutes (mm) | 2.00 |
| | Diameter (mm) | 3.00 |
| MicroPower & Micro 100 Bur Guards | Bur Head Length (mm) | 4.00 |
| 1375-011 | | 5092-291 |

| | | | |
|--|----------------------|---|---|
| | Cone Burs |  |  |
| | Flutes (mm) | 8.00 | 12.00 |
| | Diameter (mm) | 4.50 | 4.50 |
| MicroPower & Micro 100 Bur Guards | Bur Head Length (mm) | 12.00 | 12.00 |
| 1375-012 | | M45C | |
| 1375-011 | | | L45C |

| | | | | |
|--|---------------------------------------|---|---|---|
| | Tapered Cross-cut Fissure Burs |  |  |  |
| | Flutes (mm) | 701 Type | 702 Type | 703 Type |
| | Diameter (mm) | 1.20 | 1.60 | 2.10 |
| MicroPower & Micro 100 Bur Guards | Bur Head Length (mm) | 2.30 | 3.80 | 4.90 |
| 1375-012 | | 5091-271 | 5091-272 | 5091-213 |
| 1375-011 | | 5092-271 | 5092-272 | 5092-273 |

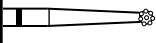
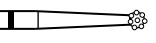
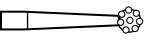
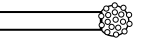
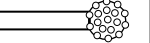
| | | | | | | |
|--|--|---|---|--|---|---|
| | Heavy Grit Diamond-Microbur. X-Long |  |  |  |  |  |
| MicroPower & Micro 100 bur guards | Diameter (mm0) | 2.00 | 3.00 | 4.00 | 5.00 | 6.00 |
| | Grit | 60-70 | 60-70 | 40-45 | 40-45 | 40-45 |
| 1375-033 & 1375-023 | | 5093-282 | 5093-283 | 5093-284 | 5093-285 | |
| 1375-032 & 1375-011 | | | 5092-283 | 5092-284 | 5092-285 | 5092-286 |

Products shown at actual size.
All products may not be available in all markets.

| | Cat. No. |
|--|----------|
| Hall 50™ Sternum Saw Handpiece..... | PR07450B |
| MPower® 2 Battery Sternum Saw..... | PR06450M |
| See pages 8, and 9 for battery accessories. | |
| Saw does not include sternum guard or blade. | |

Pneumatic Sternum Saw.....5059-005

Sternum Saw Wrench, for PR06450, PR06450M & 5059-0055059-007

Sternum Guard, 2.25" (5.72mm), for PR06450, PR06450M & 5059-005..... 5059-006

Sternum Guard, 3.12" (7.92mm), for PR06450, PR06450M & 5059-005..... 5059-011

Repeat Sternotomy Saw, Pneumatic.....5057-040



All products may not be available in all markets.

Sternum Saw Blades

Indications for Use: Primary & Repeat Sternotomy



Sternum Saw Blades

| Cat. No. | Width (mm) | Length (mm) | Non-sterile | |
|-------------|------------|-------------|-------------|--|
| 5059-235** | | 32.00 | | |
| 5059-233* | | 34.00 | | |
| 5059-532 | 10.00 | 35.00 | | |
| 5059-032-01 | 10.00 | 35.00 | 50 Pack | |
| 5059-531 | 10.00 | 54.00 | | |
| 5059-031 | 10.00 | 54.00 | | |
| 5059-031-01 | 10.00 | 54.00 | 50 Pack | |

* For use with Sarns Sternum Saw

** For use with Stryker Sternum Saw

Repeat Sternotomy Blades

| Cat. No. | Width (mm) | Length (mm) | |
|----------|------------|-------------|--|
| 1384-175 | 52.00 | 19.00 | |
| 1384-176 | 63.00 | 19.00 | |

| Cat. No. | Width (mm) | Length (mm) | |
|----------|------------|-------------|--|
| 5023-187 | 50.00 | 24.00 | |
| 5023-188 | 63.00 | 24.00 | |

All products may not be available in all markets.

Products shown at actual size.

Repeat Sternotomy Blades

| Cat. No. | Width (mm) | Length (mm) | | Cat. No. | Width (mm) | Length (mm) | |
|----------|------------|-------------|--|----------|------------|-------------|--|
| 5023-178 | 44.60 | 40.00 | | 5059-278 | 44.60 | 40.00 | |
| 5023-179 | 54.60 | 40.00 | | 5059-279 | 54.60 | 40.00 | |
| 5023-180 | 65.80 | 40.00 | | 5059-280 | 65.80 | 40.00 | |

Products shown at actual size.

All products may not be available in all markets.

Sternum Saw Blades

Indications for Use: Primary & Repeat Sternotomy



Repeat Sternotomy Blades

| Cat. No. | Width (mm) | Length (mm) | |
|----------|------------|-------------|--|
| 5071-125 | 50.00 | 19.00 | |
| 5071-126 | 63.00 | 19.00 | |
| 5071-228 | 44.50 | 40.00 | |

| Cat. No. | Width (mm) | Length (mm) | |
|----------|------------|-------------|--|
| 5071-229 | 54.50 | 40.00 | |
| 5071-230 | 66.00 | 40.00 | |

Products shown at actual size.

Handpieces

| | Cat. No. |
|-----------------------|----------|
| High Speed Drill..... | 7020-001 |
| Low Speed Drill..... | 7020-002 |
| Perforator Drive..... | 7020-003 |



7020-001



7020-002



7020-003

Attachments & Accessories

| | |
|--|----------|
| Ultrapower Footswitch..... | 7020-045 |
| Short Bur Guard (like Midas-X) Red..... | 7020-010 |
| Medium Bur Guard (like Midas-O) Copper..... | 7020-011 |
| Long Bur Guard (like Midas-M/B) Mustard..... | 7020-012 |
| X-Long Bur Guard (like Midas-AM/A) Lime..... | 7020-013 |
| Short Revision Extension (like Midas TU) Teal..... | 7020-014 |
| Medium Revision Extension (like Midas-R) Purple..... | 7020-015 |
| Long Revision Extension (like Midas RX) Blue..... | 7020-016 |
| Short Bur Guard (like Midas B-5) Black..... | 7020-017 |
| Medium Bur Guard (like Midas B-1) Green..... | 7020-018 |
| Long Bur Guard (like Midas S-1) Brown..... | 7020-019 |
| 90 degree Angle Attachment (like Midas AF/BF)..... | 7020-022 |
| Uses the 5089 and 5090 Series Burs Only | |
| 20 degree Long Keyless Attachment..... | 7020-023 |
| Uses the 5092 Series Burs Only. | |
| 20 degree Angle X-Long Keyless Attachment..... | 7020-024 |
| Uses the 5093 Series Burs Only. | |



7020-045

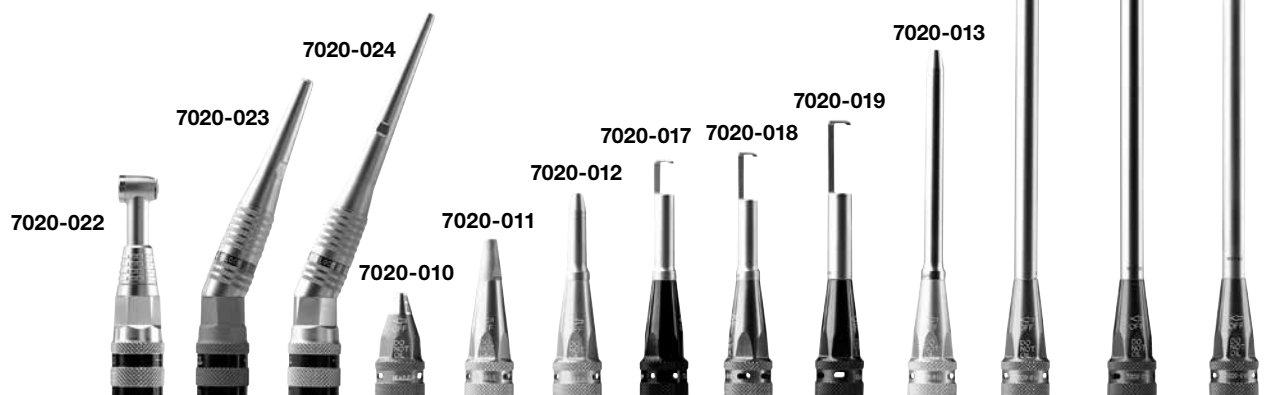

7020-016

7020-015

7020-014

7020-013

7020-019

7020-018

7020-017

7020-012

7020-011

7020-010

7020-024

7020-023









7020-022





All products may not be available in all markets.







UltraPower® Burs

Indications for Use: Otology
(Round Burs Only), Spine & Neuro









| UltraPower Bur Guard No. | Round Fluted |  |  |  |  |  |  |  |  |  |
|--------------------------|---------------|---|---|---|---|---|--|---|---|---|
| | Flutes (mm) | 4.00 | 6.00 | 6.00 | 6.00 | 8.00 | 8.00 | 8.00 | 8.00 | 8.00 |
| UltraPower Bur Guard No. | Diameter (mm) | 0.50 | 1.00 | 1.50 | 2.00 | 2.50 | 3.00 | 4.00 | 5.00 | 6.00 |
| 7020-010 | | | | | 7021-024 | 7021-025 | 7021-026 | 7021-027 | 7021-028 | 7021-029 |
| 7020-011 | | | 7021-122 | 7021-123 | 7021-124 | 7021-125 | 7021-126 | 7021-127 | 7021-128 | 7021-129 |
| 7020-012 | | 7021-220 | 7021-222 | 7021-223 | 7021-224 | 7021-225 | 7021-226 | 7021-227 | 7021-228 | 7021-229 |
| 7020-013 | | | 7021-322 | 7021-323 | 7021-324 | 7021-325 | 7021-326 | 7021-327 | 7021-328 | 7021-329 |
| 7020-014 | | | | | | | 7021-426 | 7021-427 | 7021-428 | 7021-429 |
| 7020-015 | | | | | | | 7021-526 | | 7021-528 | 7021-529 |





| UltraPower Bur Guard No. | Round Fluted |  |  |  |  |  |
|--------------------------|---------------|---|---|---|---|---|
| | Flutes (mm) | 10 | 10 | 10 | 10 | 10 |
| UltraPower Bur Guard No. | Diameter (mm) | 6.5 | 7.5 | 8.0 | 9.0 | 10.0 |
| 7020-010 | | 7021-030 | 7021-031 | 7021-034 | 7021-032 | 7021-033 |
| 7020-011 | | 7021-130 | 7021-131 | 7021-134 | 7021-132 | 7021-133 |
| 7020-012 | | 7021-230 | 7021-231 | | 7021-232 | 7021-233 |
| 7020-013 | | | 7021-331 | | 7021-332 | 7021-333 |
| 7020-014 | | | 7021-431 | | 7021-432 | 7021-433 |
| 7020-015 | | | 7021-531 | | 7021-532 | 7021-533 |
| 7020-016 | | | 7021-631 | | 7021-632 | 7021-633 |



| UltraPower Bur Guard No. | Fine Round Diamond |  |  |  |  |  |  |  |
|--------------------------|--------------------|---|---|---|---|---|---|--|
| | Diameter (mm) | 1.0 | 2.0 | 3.0 | 4.0 | 5.0 | 6.0 | 7.0 |
| 7020-010 | | | 7021-062 | 7021-063 | 7021-064 | 7021-065 | 7021-066 | |
| 7020-011 | | 7021-161 | 7021-162 | 7021-163 | 7021-164 | 7021-165 | 7021-166 | 7021-167 |
| 7020-012 | | 7021-261 | 7021-262 | 7021-263 | 7021-264 | 7021-265 | 7021-266 | 7021-267 |
| 7020-013 | | 7021-361 | 7021-362 | 7021-363 | 7021-364 | 7021-365 | 7021-366 | 7021-367 |

Products shown at actual size.

All products may not be available in all markets.

| | Coarse Round Diamond |  |  |  |  |  |  |  |
|--------------------------|----------------------|---|---|---|---|---|---|---|
| UltraPower Bur Guard No. | Diameter (mm) | 1.00 | 2.00 | 3.00 | 4.00 | 5.00 | 6.00 | 7.00 |
| 7020-010 | | | | | 7021-074 | 7021-075 | | 7021-077 |
| 7020-011 | | 7021-171 | 7021-172 | 7021-173 | 7021-174 | 7021-175 | 7021-176 | 7021-177 |
| 7020-012 | | | 7021-272 | 7021-273 | 7021-274 | 7021-275 | 7021-276 | 7021-277 |
| 7020-013 | | 7021-371 | 7021-372 | 7021-373 | 7021-374 | 7021-375 | 7021-376 | 7021-377 |
| 7020-014 | | | | | 7021-474 | | | |

| | Side Cutting, Burs |  |  |  |  |  |
|--------------------------|----------------------|---|---|---|---|---|
| | Flutes (mm) | 8.00 | 8.00 | 8.00 | 8.00 | 8.00 |
| | Diameter (mm) | 5.00 | 5.00 | 7.50 | 7.50 | 7.50 |
| UltraPower Bur Guard No. | Bur Head Length (mm) | 8.00 | 17.00 | 5.00 | 9.00 | 28.00 |
| 7020-012 | | 7021-202 | | | 7021-206 | 7021-207 |
| 7020-013 | | 7021-302 | 7021-303 | 7021-305 | | |
| 7020-014 | | | | | | 7021-427 |





| | Side Cutting Burs |  |  |  |
|--------------------------|----------------------|---|---|---|
| | Flutes (mm) | 8.00 | 8.00 | 12.00 |
| | Diameter (mm) | 9.00 | 9.00 | 10.50 |
| UltraPower Bur Guard No. | Bur Head Length (mm) | 5.00 | 9.00 | 11.00 |
| 7020-012 | | | | 7021-210 |
| 7020-013 | | | 7021-309 | 7021-310 |
| 7020-014 | | 7021-408 | 7021-409 | |
| 7020-015 | | | 7021-509 | |



Products shown at actual size.
All products may not be available in all markets.



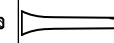

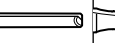
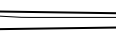
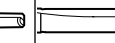
UltraPower® Burs

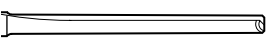
Indications for Use: Otology
(Round Burs Only), Spine & Neuro





| Ultrapower Bur Guard No. | Side Cutting Burs |  |  |  |  |  |  |  |  |
|--------------------------|----------------------|---|---|---|---|---|--|---|---|
| | Flutes (mm) | 1.00 | 1.00 | 1.00 | 2.00 | 2.00 | 2.00 | 2.00 | 2.00 |
| | Diameter (mm) | 1.50 | 1.8 | 2.00 | 1.20 | 2.20 | 2.20 | 3.00 | 3.00 |
| Ultrapower Bur Guard No. | Bur Head Length (mm) | 8.00 | 11.00 | 16.0 | 6.00 | 16.00 | 23.00 | 20.00 | 25.00 |
| 7020-010 | | 7021-012 | 7021-013 | | 7021-043 | 7021-015 | | | |
| 7020-011 | | 7021-112 | 7021-113 | 7021-114 | 7021-143 | 7021-115 | 7021-116 | | |
| 7020-012 | | | 7021-713 | 7021-214 | 7021-243 | 7021-815 | | | 7021-917 |
| 7020-013 | | | | 7021-314 | | 7021-315 | | 7021-301 | |





| Ultrapower Bur Guard No. | Side Cutting Burs |  |  |
|--------------------------|----------------------|---|---|
| | Flutes (mm) | 2.00 | 6.00 |
| | Diameter (mm) | 3.00 | 1.50 |
| Ultrapower Bur Guard No. | Bur Head Length (mm) | 36.00 | 4.90 |
| 7020-011 | | | 7021-119 |
| 7020-012 | | 7021-218 | |
| 7020-013 | | 7021-318 | |

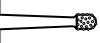

| Ultrapower Bur Guard No. | Fluted Cylindrical Burs |  |  |  |  |
|--------------------------|-------------------------|---|---|---|---|
| | Flutes (mm) | 2.00 | 2.00 | 2.00 | 2.00 |
| | Diameter (mm) | 1.80 | 1.80 | 2.20 | 3.00 |
| 7020-010 | | | | 7021-036 | 7021-037 |
| 7020-011 | | | | 7021-136 | 7021-137 |
| 7020-012 | | | 7021-235 | 7021-236 | 7021-237 |
| 7020-013 | | 7021-338 | 7021-335 | 7021-336 | 7021-337 |
| 7020-014 | | | | | 7021-437 |

Products shown at actual size.

All products may not be available in all markets.

| | | Fine Diamond Cylindrical Burs | |
|--------------------------|---------------|---|---|
| Ultrapower Bur Guard No. | Diameter (mm) |  |  |
| 7020-012 | | 1.90 | 3.00 |
| 7020-013 | | 7021-378 | 7021-379 |

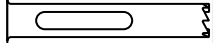
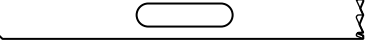
| | | Fluted Acorn Burs | | | |
|--------------------------|---------------|---|---|---|---|
| | |  |  |  |  |
| | | Flutes (mm) | | | |
| | | 8.00 | | | |
| Ultrapower Bur Guard No. | Diameter (mm) | 5.00 | 6.00 | 7.50 | 9.00 |
| 7020-010 | | | 7021-081 | | 7021-083 |
| 7020-011 | | | 7021-181 | 7021-182 | 7021-183 |
| 7020-012 | | 7021-280 | 7021-281 | 7021-282 | 7021-283 |
| 7020-013 | | 7021-380 | 7021-381 | 7021-382 | 7021-383 |
| 7020-014 | | | | 7021-482 | 7021-483 |
| 7020-015 | | | 7021-581 | | 7021-583 |
| 7020-016 | | | 7021-681 | | 7021-683 |

| | | Trephine Burs | | | |
|--------------------------|---------------|---|--|---|---|
| | |  |  |  |  |
| Ultrapower Bur Guard No. | Diameter (mm) | 3.20 | 5.30 | 10.70 | 13.50 |
| 7020-010 | | | 7021-051 | | |
| 7020-012 | | 7021-250 | | 7021-252 | 7021-253 |

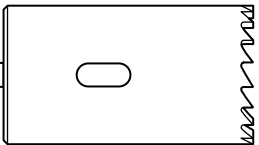
| | | Trephine Burs |
|--------------------------|---------------|---|
| | |  |
| Ultrapower Bur Guard No. | Diameter (mm) | 16.80 |
| 7020-012 | | 7021-255 |



Products shown at actual size.



All products may not be available in all markets.

UltraPower® Burs

Indications for Use: Otology
(Round Burs Only), Spine & Neuro



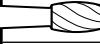

| | | Wire Pass Burs | | | |
|--------------------------|---------------|---|---|---|------|
| | |  |  |  | |
| | | Flutes (mm) | 2.00 | 2.00 | 2.00 |
| UltraPower Bur Guard No. | Diameter (mm) | 1.00 | 1.50 | 2.00 | |
| 7020-010 | | 7021-040 | 7021-041 | 7021-042 | |
| 7020-011 | | 7021-140 | 7021-141 | 7021-142 | |

| | | Oval Fluted Burs | | |
|--------------------------|----------------------|---|---|------|
| | |  |  | |
| | | Flutes (mm) | 8.00 | 8.00 |
| | | Diameter (mm) | 4.00 | 5.50 |
| UltraPower Bur Guard No. | Bur Head Length (mm) | 8.00 | 10.00 | |
| 7020-010 | | 7021-095 | 7021-096 | |
| 7020-011 | | 7021-195 | 7021-196 | |
| 7020-012 | | 7021-295 | 7021-296 | |
| 7020-013 | | 7021-395 | 7021-396 | |

| | | Fluted Frustrum Bur |
|--------------------------|---------------|---|
| | |  |
| | | Flutes (mm) |
| | | 8.00 |
| UltraPower Bur Guard No. | Diameter (mm) | 6.50 |
| 7020-013 | | 7021-391 |

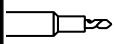
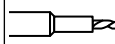
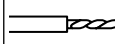
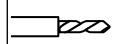
| | | Carbide Metal Cutting Burs |
|--------------------------|----------------------|--|
| | |  |
| | | Diameter (mm) |
| | | 3.20 |
| UltraPower Bur Guard No. | Bur Head Length (mm) | 15.20 |
| 7020-010 | | 7021-094 |
| 7021-012 | | 7021-294 |

| | | Wire Pass Burs – Depth Limiting | | | | |
|--------------------------|------------|---|---|---|---|------|
| | |  |  |  |  | |
| | | Diameter (mm) | 1.10 | 1.10 | 1.10 | 1.50 |
| UltraPower Bur Guard No. | Depth (mm) | 3.50 | 5.00 | 9.00 | 7.00 | |
| 7020-011 | | 7021-141-35 | 7021-141-50 | 7021-141-90 | 7021-145-70 | |

| | | Carbide Metal Cutting Burs |
|--------------------------|----------------------|---|
| | |  |
| | | Flutes (mm) |
| | | 8.00 |
| | | Diameter (mm) |
| | | 6.00 |
| UltraPower Bur Guard No. | Bur Head Length (mm) | 4.00 |
| 7020-012 | | 7021-297 |

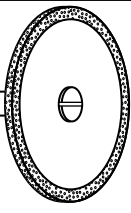
| | | Fine Diamond Wheels for Metal Cutting |
|--------------------------|---------------|---|
| | |  |
| UltraPower Bur Guard No. | Diameter (mm) | 25.40 |
| 7020-010 | | 7021-092 |
| 7020-012 | | 7021-292 |
| 7020-013 | | 7021-392 |
| 7020-014 | | 7021-492 |

Products shown at actual size.
All products may not be available in all markets.

Handpieces

CoolFlex[®] High Speed DrillE9010

High Speed Shaver E9005

Cranial Perforator Drive.....E9015

Attachments & Accessories

Medium Bur Guard for E9010 DrillE9011-1

Long Bur Guard for E9010 DrillE9011-2

X-Long Bur Guard for E9010 Drill.....E9011-3

Short Neuro Guard for E9010 Drill.....E9011-7

Medium Neuro Guard for E9010 Drill.....E9011-8

Long Neuro Guard for E9010 DrillE9011-9

Locking Collar for E9010 DrillE9012

Bur Rack, Holds up to 20 burs for E9010 DrillE9323

Drill Tubing for E9010 Drill without irrigation tipE9414

Drill Tubing for E9010 Drill with irrigation tip.....E9415A

4.2mm FESS Irrigation Tubing Set for E9005 ShaverE9416

3.7mm FESS Irrigation Tubing Set for E9005 Shaver (Not Shown).....E9417

DeClogger for removing tissue and bone from shaver blades and bursE9315

Bur Cabinet for Neuro Burs.....7020-046

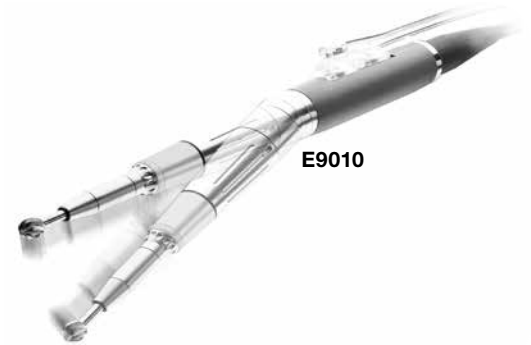

E9010



E9005



E9015

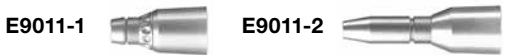

E9011-1



E9011-2



E9011-3



E9011-7



E9011-8



E9011-9



E9012



E9323



E9414



E9415A



E9416



E9315



7020-046

All products may not be available in all markets.

E9005 ENT Shaver Blades

Indications for Use: Sinus Surgery



Ideal for aggressive removal of ethmoid bone, cartilage and soft tissue



Ideal for aggressive removal of ethmoid bone, cartilage and soft tissue



Ideal for removal of soft tissue

Products not shown at actual size.
All products may not be available in all markets.

For use with:

E9005 High Speed Shaver

MicroXcisor® Blade

Cat. No.

4.2mm, Irrigated, 10.5cm Working Length, 6/Box N9330

Lynx® Blade

4.2mm, Irrigated, 10.5cm Working Length, 6/Box N9150

RhinoTec® Cuda® Blade

4.2mm, Bendable to 30°, Irrigated, 10.5cm Working Length, 6/Box E9350

3.7mm, Bendable to 30°, Irrigated, 10.5cm Working Length, 6/Box E9351

4.2mm, Bendable to 45°, 10.5cm Working Length, 6/Box A9350

4.2mm, Irrigated, 10.5cm Working Length, 6/Box N9210

3.5mm, 7.6cm Working Length, 6/Box C9952

2.9mm, 7.6cm Working Length, 6/Box C9951

2.0mm, 7.6cm Working Length, 6/Box C9950

Rhinotec® Gator® Blade

| | Cat. No. |
|--|----------|
| 4.2mm, Bendable to 30°, Irrigated, 10.5cm Working Length, 6/Box..... | E9360 |
| 3.7mm, Bendable to 30°, Irrigated, 10.5cm Working Length, 6/Box..... | E9361 |
| 4.2mm, Bendable to 45°, 10.5cm Working Length, 6/Box..... | A9360 |
| 4.2mm, Irrigated, 10.5cm Working Length, 6/Box..... | N9220 |
| 3.5mm, 7.6cm Working Length, 6/Box..... | C9962 |
| 2.9mm, 7.6cm Working Length, 6/Box..... | C9961 |
| 2.0mm, 7.6cm Working Length, 6/Box..... | C9960 |

Head & Neck Blade

| | |
|--|-------|
| 4.2mm, 11.5cm Working Length, 6/Box..... | N9321 |
| 3.5mm, 7.0cm Working Length, 6/Box..... | N9320 |

Laryngeal Blade

| | |
|---|-------|
| 3.7mm, Bendable to 45°, 20.0cm Working Length, 6/Box..... | E9363 |
|---|-------|



Ideal for aggressive removal of soft tissue, cartilage and thin bone



Ideal for the most gentle removal of soft tissue



Ideal for removal of soft tissue in laryngeal procedures

Products not shown at actual size.
All products may not be available in all markets.

E9005 ENT Shaver Blades

Indications for Use: Sinus Surgery



Ideal for aggressive removal of hard bone and cartilage



45° fixed curve (pre-bent)
Ideal for aggressive removal of hard bone



Ideal for less aggressive removal of hard bone Ideal for rhinoplasty

Rhinotec® Vortex® Router

Cat. No.

3.5mm, Hooded, 7.6cm Working Length, 6/Box C9991

2.9mm, Hooded, 7.6cm Working Length, 6/Box C9990

Curved Vortex Router

4.5mm, 45° Pre-Bent, 11.5cm Working Length, 6/Box..... N9375

Otolaryngology Bur

4.0mm, Hooded, 10.8cm Working Length, 6/Box N9390

Products not shown at actual size.
All products may not be available in all markets.

Rhinotec® Spherical Bur, Hooded

Cat. No.

4.5mm, Hooded, 10.8cm Working Length, 6/Box N9380

3.5mm, Hooded, 7.6cm Working Length, 6/Box C9912

2.9mm, Hooded, 7.6cm Working Length, 6/ BoxC9911

Rhinotec® Spherical Bur, Unhooded

3.5mm, Unhooded, 7.6cm Working Length, 6/Box..... N9382

Rhinotec Spherical Diamond Bur, Hooded

3.5mm, Hooded, 10.8cm Working Length, 6/Box N9385



Ideal for aggressive removal of hard bone and cartilage



Ideal for less aggressive removal of hard bone and cartilage



Ideal for less aggressive removal of hard bone and cartilage

Products not shown at actual size.
All products may not be available in all markets.

E Burs

Indications for Use: Otology, Spine & Neuro



*These burs may be used with multiple bur guard options to change the working length of the bur.

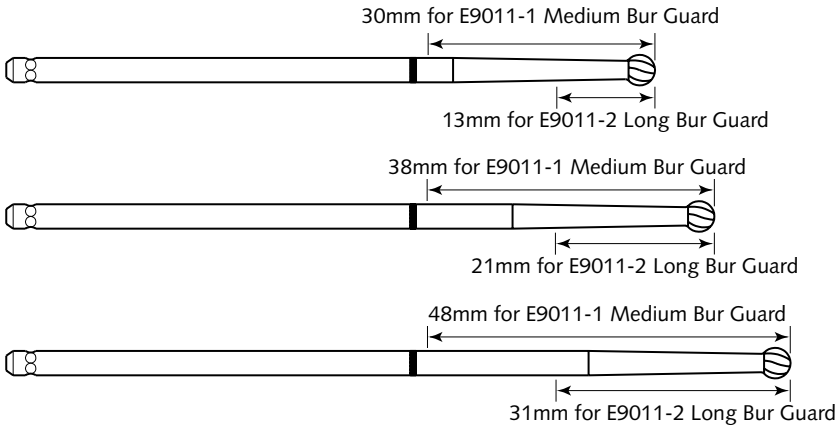

| E9010 Bur Guard No. | Round Fluted | | | | | | |
|---------------------|---------------|-------|-------|-------|-------|-------|-------|
| | Flutes (mm) | 4.00 | 4.00 | 6.00 | 6.00 | 6.00 | 8.00 |
| | Diameter (mm) | 0.50 | 0.70 | 1.00 | 1.50 | 2.00 | 2.50 |
| E9011-1 or E9011-2 | | | E8007 | E8010 | E8015 | E8020 | E8025 |
| E9011-1 or E9011-2 | | E8105 | | E8110 | E8115 | E8120 | E8125 |
| E9011-1 or E9011-2 | | E8205 | E8207 | E8210 | E8215 | E8220 | E8225 |

| Bur Guard No. | LSO Round Fluted | | | | |
|--------------------|------------------|----------|----------|----------|----------|
| | Flutes (mm) | 8.00 | 8.00 | 8.00 | 10.00 |
| | Diameter (mm) | 3.00 | 4.00 | 5.00 | 6.50 |
| E9011-1 or E9011-2 | | E8030LSO | E8040LSO | E8050LSO | E8065LSO |
| E9011-1 or E9011-2 | | E8130LSO | E8140LSO | E8150LSO | E8165LSO |
| E9011-1 or E9011-2 | | E8230LSO | E8240LSO | | E8265LSO |

| E9010 Bur Guard No. | Fine Round Diamond | | | | | | | | | | |
|---------------------|--------------------|-------|-------|-------|-------|-------|-------|-------|-------|-------|-------|
| | Diameter (mm) | 0.50 | 0.70 | 1.00 | 1.50 | 2.00 | 2.50 | 3.00 | 4.00 | 5.00 | 6.00 |
| E9011-1 or E9011-2 | | | | | | | | | E6040 | | |
| E9011-1 or E9011-2 | | E6105 | | E6110 | E6115 | E6120 | E6125 | E6130 | E6140 | E6150 | E6160 |
| E9011-1 or E9011-2 | | E6205 | E6207 | E6210 | E6215 | E6220 | E6225 | E6230 | E6240 | E6250 | |



| E9010 Bur Guard No. | Coarse Round Diamond | | | | | | | | | |
|---------------------|----------------------|-------|-------|-------|-------|-------|-------|-------|-------|-------|
| | Diameter (mm) | 1.00 | 1.50 | 2.00 | 2.50 | 3.00 | 4.00 | 5.00 | 6.00 | 7.00 |
| E9011-1 or E9011-2 | | | | E5120 | | E5160 | E5140 | E5150 | E5130 | E5170 |
| E9011-1 or E9011-2 | | E5210 | E5215 | E5220 | E5225 | E5230 | E5240 | E5050 | | |

Products shown at actual size.

All products may not be available in all markets.

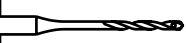
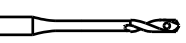
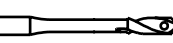
*These burs may be used with multiple bur guard options to change the working length of the bur.

| | | | | |
|---------------------------|----------------------|---|---|--|
| | Wirepass burs |  |  |  |
| | Diameter (mm) | 1.00 | 1.50 | 2.00 |
| E9010 Bur Guard No | Length (mm) | 38.00 | 38.00 | 38.00 |
| E9011-1 or E9011-2 | | E4110 | E4115 | E4120 |

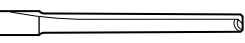
| | | | | |
|----------------------------|-----------------------------|---|---|--|
| | Neuro Burs |  |  |  |
| | Flutes (mm) | 1.00 | 2.00 | 2.00 |
| | Diameter (mm) | 1.80 | 2.20 | 3.00 |
| E9010 Bur Guard No. | Bur Head Length (mm) | 11.00 | 16.00 | 25.00 |
| E9011-7 or 7020-017 | | 7021-713 | | |
| E9011-8 or 7020-018 | | | 7021-815 | |
| 7020-019 | | | | 7021-917 |

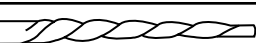
| | | |
|-------------------------------|------------------------------------|---|
| | Helical Bur for E9010 Drill |  |
| E9010 Bur Guard No. | Bur Head Length (mm) | 25.00 |
| E9011-9, E9011-2 and 7020-012 | | 7021-960 |

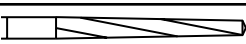
| | | |
|----------------------------|-----------------------------|---|
| | E9010 Lindemann Bur |  |
| | Diameter (mm) | 1.60 |
| E9010 Bur Guard No. | Bur Head Length (mm) | 31.00 |
| E9011-1 | | E4217 |

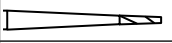
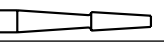
| | | | |
|----------------------------|--------------------------------|---|---|
| | E9010 Side Cutting Burs |  |  |
| | Diameter (mm) | 0.80 | 2.00 |
| E9010 Bur Guard No. | Bur Head Length (mm) | 4.90 | 7.50 |
| E9011-1 | | E4208 | E4220 |

Products shown at actual size.
All products may not be available in all markets.

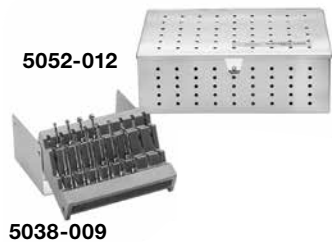

Attachments & Accessories

Cat. No.

| | |
|--|----------|
| Standard Sterilization Case | 5052-012 |
| Bur Rack, for Osteon™ and Ototom Burs..... | 5038-009 |
| Osteon/Ototome Bur Set, includes 16 burs (see System Listings Page 26) | 5056-109 |

Handpieces

| | |
|---------------------------------|----------|
| Osteon Handpiece, Straight..... | 5038-001 |
|---------------------------------|----------|

| | |
|-------------------------------|----------|
| Osteon Handpiece, Angled..... | 5038-002 |
|-------------------------------|----------|

Attachments & Accessories

| | |
|-----------------------------------|----------|
| Osteon Footswitch with Hose | 5038-004 |
|-----------------------------------|----------|

| | |
|-------------------|----------|
| Osteon Hose | 5038-005 |
|-------------------|----------|

| | |
|---|----------|
| Osteon Tubing Set with irrigation tip | 5038-600 |
|---|----------|



| Working Length (mm) | Fluted Round Burs | | | | | | | | | | | |
|---------------------|-------------------|----------|----------|----------|----------|----------|----------|----------|----------|----------|----------|----------|
| | Flutes (mm) | 4.00 | 4.00 | 6.00 | 6.00 | 6.00 | 6.00 | 8.00 | 8.00 | 8.00 | 10.00 | 10.00 |
| Diameter (mm) | 0.50 | 0.70 | 1.00 | 1.50 | 2.00 | 2.50 | 2.50 | 3.00 | 4.00 | 5.00 | 6.50 | |
| 30 | | | 5056-173 | 5056-174 | 5056-177 | 5056-178 | 5056-179 | | 5056-116 | 5056-119 | 5056-118 | 5056-117 |
| 38 | | | | | | | | | 5056-128 | 5056-127 | 5056-126 | 5056-125 |
| 48 | | 5056-166 | 5056-165 | 5056-164 | 5056-140 | 5056-142 | | 5056-149 | 5056-146 | 5056-145 | 5056-144 | |

| Working Length (mm) | Fine Diamond Round Burs | | | | | | | | | |
|---------------------|-------------------------|----------|----------|----------|----------|----------|----------|----------|----------|----------|
| | Diameter (mm) | 0.50 | 0.70 | 1.00 | 1.50 | 2.00 | 3.00 | 4.00 | 5.00 | 6.00 |
| 30 | | | | | | | | 5056-168 | 5056-147 | 5056-167 |
| 38 | | | | | | | | 5056-148 | 5056-150 | |
| 48 | | 5056-161 | 5056-160 | 5056-158 | 5056-163 | 5056-162 | 5056-159 | 5056-152 | | |

| Working Length (mm) | Coarse Diamond Round Burs | | | | | | |
|---------------------|---------------------------|----------|----------|----------|----------|----------|----------|
| | Diameter (mm) | 1.00 | 2.00 | 3.00 | 4.00 | 5.00 | 6.00 |
| 48 | | 5056-958 | 5056-962 | 5056-959 | 5056-952 | 5056-950 | 5056-967 |

| Working Length (mm) | Deep Access Burs | | | | | |
|---------------------|------------------|----------|----------|----------|----------|----------|
| | Flutes (mm) | 10.00 | 12.00 | 6.00 | | |
| Diamond | | | | Fine | Fine | |
| Diameter (mm) | 3.00 | 4.00 | 5.50 | 3.00 | 4.00 | |
| 90 | | 5056-170 | 5056-171 | | 5056-175 | 5056-176 |
| 95 | | | | 5056-172 | | |

| Working Length (mm) | Wire Pass Burs | | | |
|----------------------|----------------|----------|----------|----------|
| | Diameter (mm) | 1.00 | 1.50 | 2.00 |
| Bur Head Length (mm) | 19.00 | 19.00 | 19.00 | |
| 38 | | 5056-184 | 5056-185 | 5056-186 |

| Working Length (mm) | 80 Grit Dermabrasion Burs | | | | |
|----------------------|---------------------------|----------|----------|----------|----------|
| | Diameter (mm) | 4.00 | 7.00 | 12.00 | 10.00 |
| Bur Head Length (mm) | 15.00 | 15.00 | 15.00 | 15.00 | |
| 30 | | 5056-080 | 5056-081 | 5056-082 | 5056-083 |

Products shown at actual size.
All products may not be available in all markets.



Handpieces

Cat. No.

Cebotome® Revision Drill Handpiece 5052-041

Attachments & Accessories

Cebotome Bur Wrench.....5052-046
Cebotome Metal Cutting Bur Wrench 5052-143
Standard Bur Extension, Short, use with standard Cebotome Burs5052-042
Standard Bur Extension, Medium, use with standard Cebotome Burs5052-048
Standard Bur Extension, Long, use with standard Cebotome Burs.....5052-049
Metal Cutting Bur Extension, use with metal
cutting wheels and diamond metal cutting burs..... 5052-142
Universal Hose, 10' (3.05m)..... 5052-010

Indication for Use: Large Bone Revisions Surgery

| | | | | | | | | |
|----------------|----------|----------|----------|----------|----------|----------|----------|----------|
| Cebotome® Burs | | | | | | | | |
| Flutes (mm) | 2.00 | 2.00 | 2.00 | 10.00 | 10.00 | 10.00 | 6.00 | 6.00 |
| Diameter (mm) | 5.00 | 6.00 | 7.00 | 7.00 | 8.00 | 9.00 | 8.50 | 10.00 |
| | 5052-181 | 5052-182 | 5052-183 | 5052-184 | 5052-185 | 5052-186 | 5052-187 | 5052-188 |

| | | | | |
|---------------|----------|----------|----------|----------|
| Cebotome Burs | | | | |
| Flutes (mm) | 6.00 | 10.00 | 6.00 | 8.00 |
| Diameter (mm) | 5.00 | 10.00 | 7.00 | 8.50 |
| | 5052-189 | 5052-190 | 5052-191 | 5052-192 |

| | | |
|-------------------------------|----------|----------|
| Cebotome Metal Cutting Wheels | | |
| Grit (mm) | 150.00 | 150.00 |
| Diameter (mm) | 25.40 | 25.40 |
| | 5052-125 | 5052-126 |

| | | |
|-------------------------------------|----------|----------|
| Cebotome Diamond Metal Cutting Burs | | |
| Diameter (mm) | 3.2 | 3.2 |
| Diamond | Flat | Round |
| | 5052-144 | 5052-145 |

Products shown at actual size.

All products may not be available in all markets.

Wires & Staples

Indication for Use: Small Bone Trauma



C-Wires

| Cat. No. | Tip | Diameter | Length | Quantity |
|----------|--------|----------------|--------------|-------------|
| 5050-041 | Spade | .028" (.70mm) | 5" (13.00cm) | 50 per Pkg. |
| 5050-042 | Spade | .035" (.90mm) | 5" (13.00cm) | 50 per Pkg. |
| 5050-043 | Spade | .045" (1.10mm) | 5" (13.00cm) | 50 per Pkg. |
| 5050-044 | Spade | .062" (1.60mm) | 5" (13.00cm) | 50 per Pkg. |
| 5050-046 | Trocar | .028" (.70mm) | 5" (13.00cm) | 50 per Pkg. |
| 5050-047 | Trocar | .035" (.90mm) | 5" (13.00cm) | 50 per Pkg. |
| 5050-048 | Trocar | .045" (1.10mm) | 5" (13.00cm) | 50 per Pkg. |
| 5050-049 | Trocar | .062" (1.60mm) | 5" (13.00cm) | 50 per Pkg. |

Note: To order C-Wires in a box of 5, instead of 50 per package, please order using catalog number 5050-2XX. For example, 5051-241 instead of 5050-041.

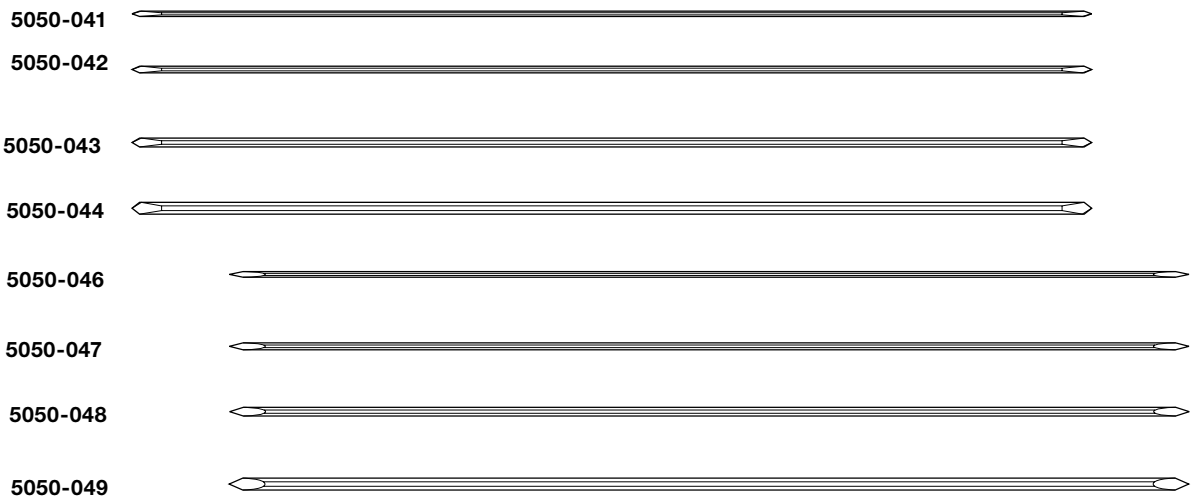

Staplizer® Cartridges

| Cat. No. | Width (mm) | Length (mm) |
|----------|------------|-------------|
| 7707-03 | 7.00 | 7.00 |
| 7710-03 | 7.00 | 10.00 |
| 7007-03 | 10.00 | 7.00 |
| 7010-03 | 10.00 | 10.00 |
| 7015-03 | 10.00 | 15.00 |
| 7307-03 | 13.00 | 7.00 |
| 7310-03 | 13.00 | 10.00 |
| 7315-03 | 13.00 | 15.00 |
| 7320-03 | 13.00 | 20.00 |
| 7610-03 | 16.00 | 10.00 |
| 7615-03 | 16.00 | 15.00 |
| 7620-03 | 16.00 | 20.00 |
| 7625-03 | 16.00 | 25.00 |

Note: 3 cartridges per Pkg.
5 Staples per cartridge.

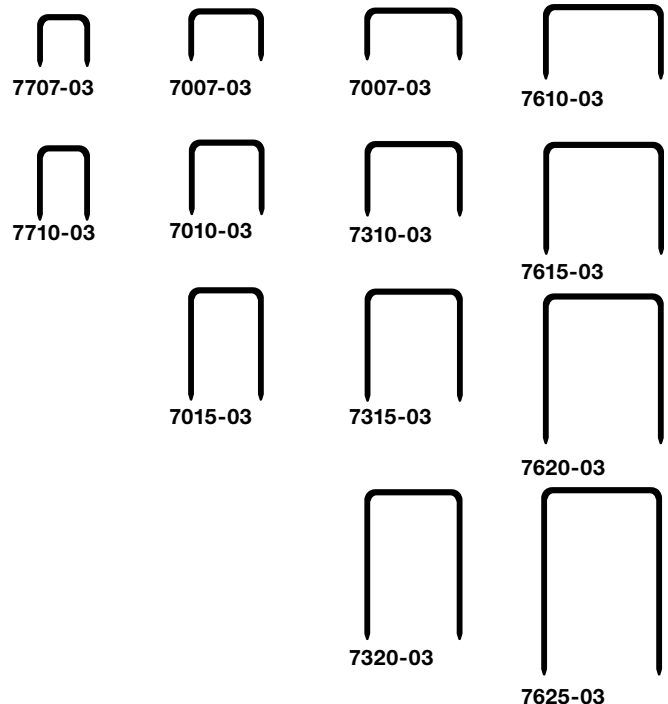

Products shown at actual size.

All products may not be available in all markets.

Sterilization Containers

| | Cat. No. |
|-----------------------------------|----------|
| Standard Sterilization Case | 5052-012 |



5052-012

Holding Clamps for use with 5030-010 & 5030-020

| | |
|-------------|----------|
| Small | 5030-028 |
| Medium..... | 5030-029 |



5030-029

5030-028

| | |
|-------------------------|----------|
| Bur Cleaning Brush..... | 1375-015 |
|-------------------------|----------|



1375-015

| | |
|--|----------|
| Cleaning Brush for Cannulated Handpieces | 5053-124 |
|--|----------|

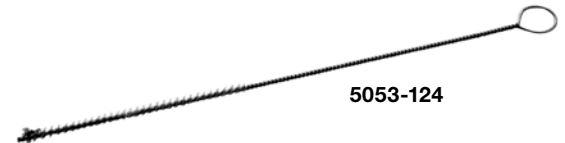

5053-124

All products may not be available in all markets.

Electric Consoles & Accessories



D4000



D3000

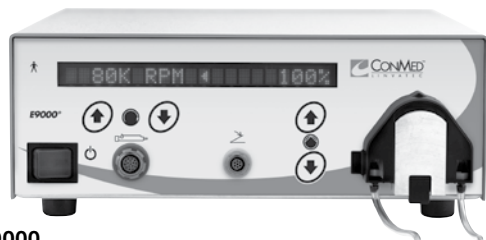

E9000

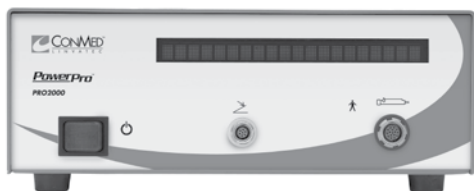

PRO2000

| | Cat. No. |
|-------------------------------------|----------|
| D4000 Console | D4000 |
| D4000 Console with Irrigation | D4000A |

| | |
|--------------------------|-------|
| Advantage® Console | D3000 |
|--------------------------|-------|

| | |
|----------------------|-------|
| E9000® Console | E9000 |
|----------------------|-------|

| | |
|-------------------------|---------|
| PowerPro® Console | PRO2000 |
|-------------------------|---------|

2-Pedal Footswitch.....**Cat. No.** 5020-053



5020-053

3-Pedal Footswitch..... C9863



C9863

Handpiece Cord..... MC5057



MC5057

AC Power Cord..... 5039-003



5039-003

Fluid Bag Support Rod for D3000 & E9000 5040-180



5040-180

Console Stand..... 5020-054



5020-054

All products may not be available in all markets.

Pneumatic Regulators, Hoses & Accessories



1375-028



Universal Hose



Extension Hose



Hose for Staplizer®



M207



M208



M322



5144-002



1375-040



M105A



M317



1365-016



1375-037

Hall® offers nitrogen specific products. Please contact customer service for information.

Cat. No.

Micro 100™ Footswitch..... 1375-028
 Universal Hose, 10' (3.05m) for Hall Handpieces 5052-010

Extension Hose, 10' (3.05m), Male Schrader to Female Schrader..... 5052-018
 Extension Hose, 10' (3.05m), Male Diss and Female Schrader 5052-029
 10' (3.05m) Hose for Staplizer® Handpiece A201

Regulator, Single Connection..... M207
 Regulator, Dual Connection M208

DISS to Schrader Adapter..... M322
 Schrader Coupler..... 5144-002

Y Connector 1375-040
 Blitz® Instrument Cleaner (Use with Staplizer Handpiece) M105A

Instrument Lubricant for Staplizer..... M317
 Hall Lubricant for Angled Attachments..... 1365-016
 Hall Lubricant for Surgical Angled Attachments 1375-037

All products may not be available in all markets.

Surgairtome Two® System

Components Ordered Separately

| | Cat. No. |
|-----------------------------------|----------|
| Surgairtome Two Handpiece | 5058-001 |
| Medium Bur Guard | 1375-012 |
| Standard Sterilization Case | 5052-012 |
| Universal Hose, 10' (3.05m)..... | 5052-010 |
| Bur Cleaning Brush..... | 1375-015 |

Ultrapower® Complete Drill System Product Listing

| | |
|--|----------|
| High Speed Drill..... | 7020-001 |
| Low Speed Drill | 7020-002 |
| Perforator Drive | 7020-003 |
| Universal Hose, 10' (3.05m)..... | 5052-010 |
| Short Bur Guard like Midas-X, Red..... | 7020-010 |
| Medium Bur Guard like Midas-O, Copper | 7020-011 |
| Long Bur Guard like Midas-M/B, Mustard | 7020-012 |
| X-Long Bur Guard like Midas-AM/A, Lime | 7020-013 |
| Short Revision Extension like Midas TU, Teal | 7020-014 |
| Medium Revision Extension like Midas-R, Purple | 7020-015 |
| Long Revision Extension like Midas RX, Blue | 7020-016 |
| Short Bur Guard like Midas B-5, Black..... | 7020-017 |
| Medium Bur Guard like Midas B-1, Green..... | 7020-018 |
| Long Bur Guard like Midas S-1, Brown | 7020-019 |
| 90 degree Angle Attachment like Midas AF/BF..... | 7020-022 |
| 20 degree Long Keyless Attachment | 7020-023 |
| 20 degree Angle X-Long Keyless Attachment | 7020-024 |
| Key Wrench, 2 per box | 7020-040 |
| Footswitch..... | 7020-045 |
| Storage Cabinet for Neuro Burs..... | 7020-046 |
| Attachment Spray | 7020-041 |



All products may not be available in all markets.



Ultrapower® Neuro/Spine Drill System Product Listing

Components Ordered Separately

| | Cat. No. |
|--|----------|
| High Speed Drill..... | 7020-001 |
| Low Speed Drill | 7020-002 |
| Perforator Drive | 7020-003 |
| Universal Hose, 10' (3.05m)..... | 5052-010 |
| Short Bur Guard like Midas-X, Red..... | 7020-010 |
| Medium Bur Guard like Midas-O, Copper | 7020-011 |
| Long Bur Guard like Midas-M/B, Mustard | 7020-012 |
| X-Long Bur Guard like Midas-AM/A, Lime | 7020-013 |
| Short Bur Guard like Midas B-5, Black..... | 7020-017 |
| Medium Bur Guard like Midas B-1, Green..... | 7020-018 |
| Long Bur Guard like Midas S-1, Brown | 7020-019 |
| 90 degree Angle Attachment like Midas AF/BF..... | 7020-022 |
| 20 degree Long Keyless Attachment | 7020-023 |
| 20 degree Angle X-Long Keyless Attachment | 7020-024 |
| Key Wrench, 2 per box | 7020-040 |
| Footswitch..... | 7020-045 |
| Storage Cabinet for Neuro Burs..... | 7020-046 |
| Attachment Spray | 7020-041 |

Ultrapower Basic Drill System Product Listing

Components Ordered Separately

| | |
|--|----------|
| High Speed Drill..... | 7020-001 |
| Universal Hose, 10' (3.05m)..... | 5052-010 |
| Short Bur Guard like Midas-X, Red..... | 7020-010 |
| Medium Bur Guard like Midas-O, Copper | 7020-011 |
| Long Bur Guard like Midas-M/B, Mustard | 7020-012 |
| X-Long Bur Guard like Midas-AM/A, Lime | 7020-013 |
| Short Revision Extension like Midas TU, Teal..... | 7020-014 |
| Medium Revision Extension like Midas-R, Purple | 7020-015 |
| Long Revision Extension like Midas RX, Blue..... | 7020-016 |
| Short Bur Guard like Midas B-5, Black..... | 7020-017 |
| Medium Bur Guard like Midas B-1, Green..... | 7020-018 |
| Long Bur Guard like Midas S-1, Brown | 7020-019 |
| 90 degree Angle Attachment like Midas AF/BF..... | 7020-022 |
| 20 degree Long Keyless Attachment | 7020-023 |
| 20 degree Angle X-Long Keyless Attachment | 7020-024 |
| Key Wrench, 2 per box | 7020-040 |
| Footswitch..... | 7020-045 |
| Storage Cabinet for Neuro Burs..... | 7020-046 |
| Attachment Spray | 7020-041 |



Osteon™/Ototome Burs

Components Ordered Separately

| | Cat. No. |
|--|----------|
| Round Carbide Bur, 6.5 x 30 mm, 2 each | 5056-117 |
| Round Carbide Bur, 5.0 x 30mm..... | 5056-118 |
| Round Carbide Bur, 4.0 x 30mm..... | 5056-119 |
| Round Carbide Bur, 5.0 x 38mm..... | 5056-126 |
| Round Steel Bur, 1.5 x 48mm..... | 5056-140 |
| Round Steel Bur, 2.0 x 48mm..... | 5056-142 |
| Round Carbide Bur, 4.0 x 48mm..... | 5056-145 |
| Round Carbide Bur, 3.0 x 48mm..... | 5056-146 |
| Round Diamond Bur, 4.0 x 48mm..... | 5056-152 |
| Round Diamond Bur, 1.0 x 48mm | 5056-158 |
| Round Diamond Bur, 3.0 x 48mm..... | 5056-159 |
| Round Diamond Bur, 0.5 x 48mm | 5056-161 |
| Round Diamond Bur, 2.0 x 48mm..... | 5056-162 |
| Round Steel Bur, 1.0 x 48mm..... | 5056-164 |
| Round Steel Bur, 0.5 x 48mm..... | 5056-166 |

Osteon Drill System with Burs

Components Ordered Separately

| | |
|---|----------|
| Bur Cleaning Brush..... | 1375-015 |
| Osteon Footswitch with Universal Hose 5052-010..... | 5038-004 |
| Osteon Hose | 5038-005 |
| Osteon/Ototome Bur Rack | 5038-009 |
| Osteon Handpiece, Straight..... | 5038-001 |
| Osteon Handpiece, Angled..... | 5038-002 |



All products may not be available in all markets.



Osteon™ Drill System without Bur System

Components Ordered Separately

| | Cat. No. |
|---|----------|
| Bur Cleaning Brush..... | 1375-015 |
| Osteon Footswitch with Universal Hose 5052-010..... | 5038-004 |
| Osteon Hose | 5038-005 |
| Osteon/Ototome Bur Rack | 5038-009 |
| Osteon Handpiece, Straight..... | 5038-001 |
| Osteon Handpiece, Angled..... | 5038-002 |



Revision Drill System

Components Ordered Separately

| | |
|---|----------|
| Universal Hose, 10' (3.05m)..... | 5052-010 |
| Cebotome Revision Drill Handpiece | 5052-041 |
| Cebotome Bur Extension, Short..... | 5052-042 |
| Cebotome Wrench..... | 5052-046 |
| Cebotome Bur Extension, Medium..... | 5052-048 |



Cebotome Metal Cutting Wheel System

Components Ordered Separately

| | |
|---|----------|
| Cebotome Metal Cutting Wheel..... | 5052-125 |
| Cebotome Metal Trimming Wheel..... | 5052-126 |
| Cebotome Metal Cutting Wheel Wrench | 5052-129 |

Cebotome Metal Cutting Bur System

Components Ordered Separately

| | |
|---|----------|
| Cebotome Metal Cutting Bur Extension | 5052-142 |
| Cebotome Metal Cutting Bur Wrench | 5052-143 |
| ST Cebotome Metal Cutting Bur, Side, Flat..... | 5052-144 |
| ST Cebotome Metal Cutting Bur, Side, Round..... | 5052-145 |

HALL®
**POWERED
INSTRUMENTS
INDEX**

| Cat. No. | Description | Page No. |
|-----------------|---|-----------------|
| 1365-005 | Replacement Hex Wrench for Micro 100 Sagittal & Oscillating Saw | 42 |
| 1365-016 | Hall Lubricant for Angled Attachments | 82 |
| 1375-003 | Bur Changer for 70 and 90 degree Angled Attachments | 43 |
| 1375-011 | Long Bur Guard | 43, 54 - 56 |
| 1375-011P | Long Precision Bur Guard | 43 |
| 1375-012 | Medium Bur Guard | 43, 54 - 56, 83 |
| 1375-012P | Medium Precision Bur Guard | 43 |
| 1375-015 | Bur Cleaning Brush | 79, 83, 85, 86 |
| 1375-020 | Laminectomy Guard | 43, 55 |
| 1375-021 | Rhinoplasty Guard | 43 |
| 1375-023 | X-Long Bur Guard | 43, 54, 55, 56 |
| 1375-023P | X-Long Precision Bur Guard | 43 |
| 1375-028 | Micro 100 Footswitch | 82 |
| 1375-032 | 20 degree Angled Attachment | 43, 54, 56 |
| 1375-033 | 20 degree X-Long Angled Attachment | 43, 56 |
| 1375-034 | 70 degree Contra Angle with Dental Head | 43 |
| 1375-035 | 70 degree Contra Angle with Surgical Head | 43, 54, 55 |
| 1375-036 | 90 degree Angled Attachment | 43, 54, 55 |
| 1375-037 | Hall Lubricant for Surgical Angled Attachments | 82 |
| 1375-040 | Y Connector | 82 |
| 1375-112 | Burguard Sleeve Surgairtome Two | 42 |
| 1384-175 | Repeat Sternotomy Blade | 58 |
| 1384-176 | Repeat Sternotomy Blade | 58 |
| 1387-022 | Tissue Retractor | 43, 54, 55 |
| 5020-053 | 2-Pedal Footswitch | 81 |
| 5020-054 | Console Stand | 81 |
| 5020-160 | Smartguard | 42 |
| 5023-055 | Micro Dermabrader Sagittal Saw Blade | 49 |
| 5023-056 | Micro Dermabrader Sagittal Saw Blade | 49 |
| 5023-057 | Micro Dermabrader Sagittal Saw Blade | 49 |
| 5023-101 | Micro Intra-Oral Oscillating Saw Blade | 51 |
| 5023-102 | Micro Intra-Oral Oscillating Saw Blade | 51 |
| 5023-103 | Micro Intra-Oral Oscillating Saw Blade | 51 |
| 5023-104 | Micro Intra-Oral Oscillating Saw Blade | 51 |
| 5023-118 | Micro Sagittal Saw Blade | 45 |
| 5023-128 | Micro Angled Sagittal Saw Blade | 47 |
| 5023-129 | Micro Angled Sagittal Saw Blade | 47 |
| 5023-130 | Micro Sagittal Saw Blade | 45 |
| 5023-131 | Micro Sagittal Saw Blade | 45 |
| 5023-132 | Micro Sagittal Saw Blade | 45 |
| 5023-133 | Micro Sagittal Saw Blade | 45 |
| 5023-134 | Micro Angled Sagittal Saw Blade | 47 |
| 5023-135 | Micro Angled Sagittal Saw Blade | 47 |
| 5023-136 | Micro Angled Sagittal Saw Blade | 47 |
| 5023-137 | Micro Sagittal Saw Blade | 45 |
| 5023-138 | Micro Sagittal Saw Blade | 45 |
| 5023-139 | Micro Sagittal Saw Blade | 45 |
| 5023-140 | Micro Sagittal Saw Blade | 45 |
| 5023-141 | Micro Sagittal Saw Blade | 46 |
| 5023-142 | Micro Sagittal Saw Blade | 46 |
| 5023-143 | Micro Sagittal Saw Blade | 46 |
| 5023-144 | Micro Sagittal Saw Blade | 45 |
| 5023-160 | Micro Oscillating Saw Blade | 50 |
| 5023-161 | Micro Oscillating Saw Blade | 50 |
| 5023-162 | Micro Oscillating Saw Blade | 50 |

| Cat. No. | Description | Page No. |
|-----------------|---|-----------------|
| 5023-163 | Micro Oscillating Saw Blade | 50 |
| 5023-164 | Micro Oscillating Saw Blade | 50 |
| 5023-165 | Micro Oscillating Saw Blade | 50 |
| 5023-166 | Micro Oscillating Saw Blade | 50 |
| 5023-167 | Micro Angled Oscillating Saw Blade | 50 |
| 5023-168 | Micro Angled Oscillating Saw Blade | 50 |
| 5023-169 | Micro Oscillating Saw Blade | 50 |
| 5023-170 | Micro Crescentic Oscillating Saw Blade | 52 |
| 5023-171 | Micro Crescentic Oscillating Saw Blade | 52 |
| 5023-172 | Micro Crescentic Oscillating Saw Blade | 52 |
| 5023-176 | Micro Crescentic Oscillating Saw Blade | 52 |
| 5023-178 | Repeat Sternotomy Blade | 59 |
| 5023-179 | Repeat Sternotomy Blade | 59 |
| 5023-180 | Repeat Sternotomy Blade | 59 |
| 5023-182 | Micro ACL Sagittal Saw Blade | 48 |
| 5023-183 | Micro ACL Sagittal Saw Blade | 48 |
| 5023-184 | Micro ACL Sagittal Saw Blade | 48 |
| 5023-185 | Micro ACL Sagittal Saw Blade | 48 |
| 5023-186 | Micro ACL Sagittal Saw Blade | 48 |
| 5023-187 | Repeat Sternotomy Blade | 58 |
| 5023-188 | Repeat Sternotomy Blade | 58 |
| 5023-244 | Micro Sagittal Saw Blade | 46 |
| 5023-247 | Micro Sagittal Saw Blade | 46 |
| 5023-249 | Micro Sagittal Saw Blade | 46 |
| 5023-258 | Micro Angled Oscillating Saw Blade | 50 |
| 5023-259 | Micro Angled Oscillating Saw Blade | 50 |
| 5023-405 | Micro Graft Harvesting Sagittal Saw Blade | 49 |
| 5023-406 | Micro Graft Harvesting Sagittal Saw Blade | 49 |
| 5023-407 | Micro Graft Harvesting Sagittal Saw Blade | 49 |
| 5023-408 | Micro Graft Harvesting Sagittal Saw Blade | 49 |
| 5023-409 | Micro Graft Harvesting Sagittal Saw Blade | 49 |
| 5023-410 | Micro Graft Harvesting Sagittal Saw Blade | 49 |
| 5023-411 | Micro Graft Harvesting Sagittal Saw Blade | 49 |
| 5023-412 | Micro Graft Harvesting Sagittal Saw Blade | 49 |
| 5023-413 | Micro Graft Harvesting Sagittal Saw Blade | 49 |
| 5030-028 | Small Holding Clamps | 79 |
| 5030-029 | Medium Holding Clamps | 79 |
| 5038-001 | Osteon Handpiece, Straight | 74, 85, 86 |
| 5038-002 | Osteon Handpiece, Angled | 74, 85, 86 |
| 5038-004 | Osteon Footswitch with Hose | 74, 85, 86 |
| 5038-005 | Osteon Hose | 74, 85, 86 |
| 5038-009 | Bur Rack, for Osteon and Ototom Burs | 74, 85, 86 |
| 5038-600 | Osteon Tubing Set with irrigation tip | 74 |
| 5039-003 | AC Power Cord | 81 |
| 5040-180 | Fluid Bag Support Rod for D3000 & E9000 | 81 |
| 5044-145 | Micro Sagittal Saw Blade | 46 |
| 5044-999-52 | 1/4" (6.35mm) Replacement Chuck Key | 13 |
| 5044-999-53 | 5/32" (4.0mm) Replacement Chuck Key | 13 |
| 5050-041 | C-Wire | 78 |
| 5050-042 | C-Wire | 78 |
| 5050-043 | C-Wire | 78 |
| 5050-044 | C-Wire | 78 |
| 5050-046 | C-Wire | 78 |
| 5050-047 | C-Wire | 78 |
| 5050-048 | C-Wire | 78 |

| Cat. No. | Description | Page No. |
|-----------------|--|-----------------|
| 5050-049 | C-Wire | 78 |
| 5052-010 | Universal Hose, 10' (3.05m) | 76, 82 - 84, 86 |
| 5052-012 | Standard Sterilization Case | 74, 79, 83 |
| 5052-018 | Extension Hose, 10' (3.05m), Male Schrader to Female Schrader | 82 |
| 5052-029 | Extension Hose, 10' (3.05m), Male Diss and Female Schrader | 82 |
| 5052-041 | Cebotome Revision Drill Handpiece | 76, 86 |
| 5052-042 | Standard Bur Extension, Short, use with standard Cebotome Burs | 76, 86 |
| 5052-046 | Cebotome Bur Wrench | 76, 86 |
| 5052-048 | Standard Bur Extension, Medium, use with standard Cebotome Burs | 76, 86 |
| 5052-049 | Standard Bur Extension, Long, use with standard Cebotome Burs | 76 |
| 5052-125 | Cebotome Metal Cutting Wheels | 77, 86 |
| 5052-126 | Cebotome Metal Cutting Wheels | 77, 86 |
| 5052-129 | Cebotome Metal Cutting Wheel Wrench | 86 |
| 5052-135 | Stryker Large Bone Reciprocating Blade | 39 |
| 5052-142 | Metal Cutting Bur Extension | 76, 86 |
| 5052-143 | Cebotome Metal Cutting Bur Wrench | 76, 86 |
| 5052-144 | Cebotome Diamond Metal Cutting Bur | 77, 86 |
| 5052-145 | Cebotome Diamond Metal Cutting Bur | 77, 86 |
| 5052-173 | Hall Large Bone Reciprocating Blade | 38 |
| 5052-179 | Hall Large Bone Reciprocating Blade | 38 |
| 5052-181 | Cebotome Bur | 77 |
| 5052-182 | Cebotome Bur | 77 |
| 5052-183 | Cebotome Bur | 77 |
| 5052-184 | Cebotome Bur | 77 |
| 5052-185 | Cebotome Bur | 77 |
| 5052-186 | Cebotome Bur | 77 |
| 5052-187 | Cebotome Bur | 77 |
| 5052-188 | Cebotome Bur | 77 |
| 5052-189 | Cebotome Bur | 77 |
| 5052-190 | Cebotome Bur | 77 |
| 5052-191 | Cebotome Bur | 77 |
| 5052-192 | Cebotome Bur | 77 |
| 5052-258 | Hall Large Bone Reciprocating Blade | 38 |
| 5052-259 | Hall Large Bone Reciprocating Blade | 38 |
| 5052-260 | Hall Large Bone Reciprocating Blade | 38 |
| 5052-261 | Hall Large Bone Reciprocating Blade | 38 |
| 5052-276 | Hall Large Bone Reciprocating Blade | 38 |
| 5052-281 | Hall Large Bone Reciprocating Blade | 38 |
| 5052-291 | Hall Large Bone Reciprocating Blade | 38 |
| 5052-332 | Stryker Large Bone Reciprocating Blade | 39 |
| 5052-333 | Stryker Large Bone Reciprocating Blade | 39 |
| 5052-334 | Stryker Large Bone Reciprocating Blade | 39 |
| 5053-009 | Micro 100 Medium Speed Drill | 42 |
| 5053-010 | Micro 100 Reciprocating Saw | 42 |
| 5053-011 | Micro 100 Sagittal Saw | 42 |
| 5053-012 | Micro 100 Oscillating Saw | 42 |
| 5053-013 | Micro 100 Wire Driver | 42 |
| 5053-019 | Wire Driver Adapter Chuck for use with 5053-013 | 42 |
| 5053-022 | Micro 100 XL Oscillating Saw | 42 |
| 5053-050 | Micro Depth Limiting Reciprocating Saw Blade | 53 |
| 5053-051 | Micro Depth Limiting Reciprocating Saw Blade | 53 |
| 5053-052 | Micro Depth Limiting Reciprocating Saw Blade | 53 |
| 5053-053 | Micro Depth Limiting Reciprocating Saw Blade | 53 |
| 5053-054 | Micro Reciprocating Saw Blade | 53 |
| 5053-074 | Micro 100 Throttle Clip (for lever) Used during footswitch operation | 42 |

| Cat. No. | Description | Page No. |
|----------|--|----------|
| 5053-080 | Micro Reciprocating Rasp | 53 |
| 5053-081 | Micro Reciprocating Rasp | 53 |
| 5053-082 | Micro Reciprocating Rasp | 53 |
| 5053-083 | Micro Reciprocating Rasp | 53 |
| 5053-084 | Micro Reciprocating Rasp | 53 |
| 5053-085 | Micro Reciprocating Rasp | 53 |
| 5053-122 | Micro Reciprocating Saw Blade | 53 |
| 5053-123 | Wire Guard for use with 5053-013 | 42 |
| 5053-124 | Cleaning Brush for Cannulated Handpieces | 79 |
| 5053-126 | Micro Reciprocating Saw Blade | 53 |
| 5053-220 | Micro Reciprocating Saw Blade | 53 |
| 5053-221 | Micro Reciprocating Saw Blade | 53 |
| 5056-080 | 80 Grit Dermabrasion Osteon Bur | 75 |
| 5056-081 | 80 Grit Dermabrasion Osteon Bur | 75 |
| 5056-082 | 80 Grit Dermabrasion Osteon Bur | 75 |
| 5056-083 | 80 Grit Dermabrasion Osteon Bur | 75 |
| 5056-109 | Osteon/Ototome Bur Set, includes 16 burs (see System Listings Page 26) | 74 |
| 5056-116 | Fluted Round Osteon Bur | 75 |
| 5056-117 | Fluted Round Osteon Bur | 75, 85 |
| 5056-118 | Fluted Round Osteon Bur | 75, 85 |
| 5056-119 | Fluted Round Osteon Bur | 75, 85 |
| 5056-125 | Fluted Round Osteon Bur | 75 |
| 5056-126 | Fluted Round Osteon Bur | 75, 85 |
| 5056-127 | Fluted Round Osteon Bur | 75 |
| 5056-128 | Fluted Round Osteon Bur | 75 |
| 5056-140 | Fluted Round Osteon Bur | 75, 85 |
| 5056-142 | Fluted Round Osteon Bur | 75, 85 |
| 5056-144 | Fluted Round Osteon Bur | 75 |
| 5056-145 | Fluted Round Osteon Bur | 75, 85 |
| 5056-146 | Fluted Round Osteon Bur | 75, 85 |
| 5056-147 | Fine Diamond Round Osteon Bur | 75 |
| 5056-148 | Fine Diamond Round Osteon Bur | 75 |
| 5056-149 | Fluted Round Osteon Bur | 75 |
| 5056-150 | Fine Diamond Round Osteon Bur | 75 |
| 5056-152 | Fine Diamond Round Osteon Bur | 75, 85 |
| 5056-158 | Fine Diamond Round Osteon Bur | 75, 85 |
| 5056-159 | Fine Diamond Round Osteon Bur | 75, 85 |
| 5056-160 | Fine Diamond Round Osteon Bur | 75 |
| 5056-161 | Fine Diamond Round Osteon Bur | 75, 85 |
| 5056-162 | Fine Diamond Round Osteon Bur | 75, 85 |
| 5056-163 | Fine Diamond Round Osteon Bur | 75 |
| 5056-164 | Fluted Round Osteon Bur | 75, 85 |
| 5056-165 | Fluted Round Osteon Bur | 75 |
| 5056-166 | Fluted Round Osteon Bur | 75, 85 |
| 5056-167 | Fine Diamond Round Osteon Bur | 75 |
| 5056-168 | Fine Diamond Round Osteon Bur | 75 |
| 5056-170 | Deep Access Osteon Bur | 75 |
| 5056-171 | Deep Access Osteon Bur | 75 |
| 5056-172 | Deep Access Osteon Bur | 75 |
| 5056-173 | Fluted Round Osteon Bur | 75 |
| 5056-174 | Fluted Round Osteon Bur | 75 |
| 5056-175 | Deep Access Osteon Bur | 75 |
| 5056-176 | Deep Access Osteon Bur | 75 |
| 5056-177 | Fluted Round Osteon Bur | 75 |
| 5056-178 | Fluted Round Osteon Bur | 75 |

| Cat. No. | Description | Page No. |
|-----------------|---|-----------------|
| 5056-179 | Fluted Round Osteon Bur | 75 |
| 5056-184 | Wire Pass Osteon Bur | 75 |
| 5056-185 | Wire Pass Osteon Bur | 75 |
| 5056-186 | Wire Pass Osteon Bur | 75 |
| 5056-950 | Coarse Diamond Round Osteon Bur | 75 |
| 5056-952 | Coarse Diamond Round Osteon Bur | 75 |
| 5056-958 | Coarse Diamond Round Osteon Bur | 75 |
| 5056-959 | Coarse Diamond Round Osteon Bur | 75 |
| 5056-962 | Coarse Diamond Round Osteon Bur | 75 |
| 5056-967 | Coarse Diamond Round Osteon Bur | 75 |
| 5057-040 | Repeat Sternotomy Saw, Pneumatic | 57 |
| 5058-000 | Surgairtome Two® High Speed Drill Kit (System listing on page xx) | 42 |
| 5058-001 | Surgairtome Two High Speed Drill | 42 |
| 5058-001 | Surgairtome Two Handpiece | 83 |
| 5059-005 | Pneumatic Sternum Saw | 57 |
| 5059-006 | Sternum Guard, 2.25" (5.72mm), for PRO6450, PRO6450M | 57 |
| 5059-007 | Sternum Saw Wrench, for PRO6450, PRO6450M & 5059-005 | 57 |
| 5059-011 | Sternum Guard, 3.12" (7.92mm), for PRO6450, PRO6450M | 57 |
| 5059-031 | Sternum Saw Blade | 58 |
| 5059-031-01 | Sternum Saw Blade | 58 |
| 5059-032-01 | Sternum Saw Blade | 58 |
| 5059-233 | Sternum Saw Blade | 58 |
| 5059-235 | Sternum Saw Blade | 58 |
| 5059-278 | Repeat Sternotomy Blade | 59 |
| 5059-279 | Repeat Sternotomy Blade | 59 |
| 5059-280 | Repeat Sternotomy Blade | 59 |
| 5059-531 | Sternum Saw Blade | 58 |
| 5059-532 | Sternum Saw Blade | 58 |
| 5071-105 | ACL Graft Harvesting, Large Bone Oscillating Blade | 31 |
| 5071-106 | ACL Graft Harvesting, Large Bone Oscillating Blade | 31 |
| 5071-107 | ACL Graft Harvesting, Large Bone Oscillating Blade | 31 |
| 5071-108 | ACL Graft Harvesting, Large Bone Oscillating Blade | 31 |
| 5071-109 | ACL Graft Harvesting, Large Bone Oscillating Blade | 31 |
| 5071-110 | ACL Graft Harvesting, Large Bone Oscillating Blade | 31 |
| 5071-111 | ACL Graft Harvesting, Large Bone Oscillating Blade | 31 |
| 5071-112 | ACL Graft Harvesting, Large Bone Oscillating Blade | 31 |
| 5071-113 | ACL Graft Harvesting, Large Bone Oscillating Blade | 31 |
| 5071-120 | Hall Large Bone Knee Blade | 20 |
| 5071-121 | Hall Large Bone Knee Blade | 21 |
| 5071-123 | Hall Large Bone Knee Blade | 24 |
| 5071-124 | Hall Large Bone Knee Blade | 25 |
| 5071-125 | Repeat Sternotomy Blade | 60 |
| 5071-126 | Repeat Sternotomy Blade | 60 |
| 5071-127 | ACL Large Bone Oscillating Blade | 32 |
| 5071-129 | Hall Large Bone Knee Blade | 25 |
| 5071-132 | Large Bone Oscillating Blade | 34 |
| 5071-133 | ACL Large Bone Oscillating Blade | 32 |
| 5071-134 | ACL Large Bone Oscillating Blade | 32 |
| 5071-135 | ACL Large Bone Oscillating Blade | 33 |
| 5071-140 | Large Bone Oscillating Blade | 37 |
| 5071-141 | Large Bone Oscillating Blade | 36 |
| 5071-142 | Large Bone Oscillating Blade | 37 |
| 5071-143 | Large Bone Oscillating Blade | 36 |
| 5071-144 | Hall Large Bone Knee Blade | 26 |
| 5071-145 | Large Bone Oscillating Blade | 37 |

| Cat. No. | Description | Page No. |
|-----------------|----------------------------------|-----------------|
| 5071-146 | Hall Large Bone Knee Blade | 20 |
| 5071-161 | Hall Large Bone Knee Blade | 24 |
| 5071-163 | Hall Large Bone Knee Blade | 26 |
| 5071-166 | Large Bone Oscillating Blade | 34 |
| 5071-167 | Hall Large Bone Knee Blade | 21 |
| 5071-174 | Large Bone Oscillating Blade | 36 |
| 5071-175 | Large Bone Oscillating Abrader | 37 |
| 5071-177 | Large Bone Oscillating Blade | 35 |
| 5071-178 | Large Bone Oscillating Blade | 35 |
| 5071-180 | Hall Large Bone Knee Blade | 23 |
| 5071-181 | Hall Large Bone Knee Blade | 23 |
| 5071-184 | Hall Large Bone Knee Blade | 21 |
| 5071-185 | Hall Large Bone Knee Blade | 20 |
| 5071-186 | Large Bone Oscillating Blade | 35 |
| 5071-187 | Large Bone Oscillating Blade | 35 |
| 5071-188 | Large Bone Oscillating Blade | 35 |
| 5071-195 | Hall Large Bone Knee Blade | 20 |
| 5071-196 | Hall Large Bone Knee Blade | 20 |
| 5071-201 | Hall Large Bone Knee Blade | 23 |
| 5071-228 | Repeat Sternotomy Blade | 60 |
| 5071-229 | Repeat Sternotomy Blade | 60 |
| 5071-230 | Repeat Sternotomy Blade | 60 |
| 5071-236 | ACL Large Bone Oscillating Blade | 32 |
| 5071-246 | ACL Large Bone Oscillating Blade | 32 |
| 5071-300 | Intrex Blade | 17 |
| 5071-301 | Intrex Blade | 17 |
| 5071-302 | Intrex Blade | 17 |
| 5071-303 | Intrex Blade | 17 |
| 5071-304 | Intrex Blade | 17 |
| 5071-305 | Intrex Blade | 17 |
| 5071-306 | Intrex Blade | 17 |
| 5071-310 | Intrex Blade | 17 |
| 5071-311 | Intrex Blade | 17 |
| 5071-312 | Intrex Blade | 17 |
| 5071-313 | Intrex Blade | 17 |
| 5071-314 | Intrex Blade | 17 |
| 5071-315 | Intrex Blade | 17 |
| 5071-316 | Intrex Blade | 17 |
| 5071-320 | Intrex Blade | 17 |
| 5071-321 | Intrex Blade | 17 |
| 5071-322 | Intrex Blade | 17 |
| 5071-323 | Intrex Blade | 17 |
| 5071-324 | Intrex Blade | 17 |
| 5071-325 | Intrex Blade | 17 |
| 5071-326 | Intrex Blade | 17 |
| 5071-330 | Intrex Blade | 17 |
| 5071-331 | Intrex Blade | 17 |
| 5071-332 | Intrex Blade | 17 |
| 5071-333 | Intrex Blade | 17 |
| 5071-334 | Intrex Blade | 17 |
| 5071-335 | Intrex Blade | 17 |
| 5071-336 | Intrex Blade | 17 |
| 5071-340 | Intrex Blade | 17 |
| 5071-341 | Intrex Blade | 17 |
| 5071-342 | Intrex Blade | 17 |

| Cat. No. | Description | Page No. |
|-----------------|----------------------------------|-----------------|
| 5071-343 | Intrex Blade | 17 |
| 5071-344 | Intrex Blade | 17 |
| 5071-345 | Intrex Blade | 17 |
| 5071-346 | Intrex Blade | 17 |
| 5071-350 | Intrex Blade | 17 |
| 5071-351 | Intrex Blade | 17 |
| 5071-352 | Intrex Blade | 17 |
| 5071-353 | Intrex Blade | 17 |
| 5071-354 | Intrex Blade | 17 |
| 5071-355 | Intrex Blade | 17 |
| 5071-356 | Intrex Blade | 17 |
| 5071-519 | Hall Large Bone Knee Blade | 25 |
| 5071-525 | Hall Large Bone Knee Blade | 26 |
| 5071-526 | Hall Large Bone Knee Blade | 22 |
| 5071-527 | Hall Large Bone Knee Blade | 23 |
| 5071-528 | Hall Large Bone Knee Blade | 19 |
| 5071-529 | Hall Large Bone Knee Blade | 25 |
| 5071-530 | Hall Large Bone Knee Blade | 26 |
| 5071-531 | Hall Large Bone Knee Blade | 23 |
| 5071-532 | Hall Large Bone Knee Blade | 20 |
| 5071-533 | Hall Large Bone Knee Blade | 19 |
| 5071-534 | Hall Large Bone Knee Blade | 22 |
| 5071-538 | Hall Large Bone Knee Blade | 21 |
| 5071-539 | Hall Large Bone Knee Blade | 26 |
| 5071-547 | Hall Large Bone Knee Blade | 21 |
| 5071-548 | Hall Large Bone Knee Blade | 21 |
| 5071-550 | Large Bone Oscillating Blade | 34 |
| 5071-551 | Large Bone Oscillating Blade | 34 |
| 5071-552 | Large Bone Oscillating Blade | 34 |
| 5071-553 | Large Bone Oscillating Blade | 34 |
| 5071-554 | Large Bone Oscillating Blade | 36 |
| 5071-555 | Large Bone Oscillating Blade | 37 |
| 5071-556 | Large Bone Oscillating Blade | 35 |
| 5071-557 | Large Bone Oscillating Blade | 36 |
| 5071-558 | Hall Large Bone Knee Blade | 22 |
| 5071-560 | Large Bone Oscillating Blade | 36 |
| 5071-562 | Hall Large Bone Knee Blade | 21 |
| 5071-564 | Hall Large Bone Knee Blade | 24 |
| 5071-565 | Hall Large Bone Knee Blade | 26 |
| 5071-568 | Hall Large Bone Knee Blade | 24 |
| 5071-570-50 | Hall Large Bone Knee Blade | 22 |
| 5071-571 | ACL Large Bone Oscillating Blade | 33 |
| 5071-572 | Large Bone Oscillating Blade | 35 |
| 5071-573 | Hall Large Bone Knee Blade | 22 |
| 5071-575 | Hall Large Bone Knee Blade | 22 |
| 5071-576 | Hall Large Bone Knee Blade | 24 |
| 5071-582 | Hall Large Bone Knee Blade | 23 |
| 5071-583 | Hall Large Bone Knee Blade | 19 |
| 5071-589 | Hall Large Bone Knee Blade | 20 |
| 5071-590 | Hall Large Bone Knee Blade | 24 |
| 5071-594 | Hall Large Bone Knee Blade | 19 |
| 5071-650 | Hall Large Bone Knee Blade | 19 |
| 5072-100 | Stryker Large Bone Knee Blade | 27 |
| 5072-101 | Stryker Large Bone Knee Blade | 29 |
| 5072-102 | Stryker Large Bone Knee Blade | 27, 28 |

| Cat. No. | Description | Page No. |
|-----------------|---------------------------------------|-----------------|
| 5072-105 | Stryker Large Bone Knee Blade | 28 |
| 5072-109 | Stryker Large Bone Knee Blade | 28 |
| 5072-110 | Stryker Large Bone Knee Blade | 29 |
| 5072-111 | Stryker Large Bone Knee Blade | 29 |
| 5072-140 | Stryker Large Bone Knee Blade | 27 |
| 5072-142 | Stryker Large Bone Knee Blade | 28 |
| 5072-143 | Stryker Large Bone Knee Blade | 27 |
| 5072-145 | Stryker Large Bone Knee Blade | 27 |
| 5072-150 | Stryker Large Bone Knee Blade | 27 |
| 5072-151 | Stryker Large Bone Knee Blade | 28 |
| 5072-152 | Stryker Large Bone Knee Blade | 28 |
| 5072-158 | Stryker Large Bone Knee Blade | 29 |
| 5072-176 | Stryker Large Bone Knee Blade | 30 |
| 5072-177 | Stryker Large Bone Knee Blade | 30 |
| 5072-181 | Stryker Large Bone Knee Blade | 29 |
| 5072-183 | Stryker Large Bone Knee Blade | 29 |
| 5072-185 | Stryker Large Bone Knee Blade | 29 |
| 5072-195 | Stryker Large Bone Knee Blade | 28 |
| 5072-218 | Stryker Large Bone Knee Blade | 29 |
| 5089-208 | Micro Straight Side – Cutting Bur | 55 |
| 5090-247 | Micro Wire Pass Bur | 54 |
| 5090-248 | Micro Wire Pass Bur | 54 |
| 5090-249 | Micro Wire Pass Bur | 54 |
| 5091-080 | Micro Dermabraders – Fine Diamond Bur | 54 |
| 5091-081 | Micro Dermabraders – Fine Diamond Bur | 54 |
| 5091-082 | Micro Dermabraders – Fine Diamond Bur | 54 |
| 5091-083 | Micro Dermabraders – Fine Diamond Bur | 54 |
| 5091-201 | Micro Straight Side – Cutting Bur | 55 |
| 5091-202 | Micro Straight Side – Cutting Bur | 55 |
| 5091-204 | Micro Straight Side – Cutting Bur | 55 |
| 5091-206 | Micro Tapered Side – Cutting Bur | 55 |
| 5091-212 | Micro Lindemann Bur | 56 |
| 5091-213 | Micro Tapered Cross-cut Fissure Bur | 56 |
| 5091-214 | Micro Tapered Side – Cutting Bur | 55 |
| 5091-215 | Micro Tapered Side – Cutting Bur | 55 |
| 5091-216 | Micro Straight Side – Cutting Bur | 55 |
| 5091-217 | Micro Straight Side – Cutting Bur | 55 |
| 5091-218 | Micro Tapered Side – Cutting Bur | 55 |
| 5091-219 | Micro Tapered Side – Cutting Bur | 55 |
| 5091-221 | Micro Round Fluted Bur | 54 |
| 5091-222 | Micro Round Fluted Bur | 54 |
| 5091-223 | Micro Round Fluted Bur | 54 |
| 5091-224 | Micro Round Fluted Bur | 54 |
| 5091-225 | Micro Round Fluted Bur | 54 |
| 5091-226 | Micro Round Fluted Bur | 54 |
| 5091-228 | Micro Round Fluted Bur | 54 |
| 5091-230 | Micro Round Fluted Bur | 54 |
| 5091-232 | Micro Round Fluted Bur | 54 |
| 5091-236 | Micro Oval Bur | 55 |
| 5091-238 | Micro Oval Bur | 55 |
| 5091-242 | Micro Swanson Reamer Bur | 54 |
| 5091-243 | Micro Swanson Reamer Bur | 54 |
| 5091-244 | Micro Swanson Reamer Bur | 54 |
| 5091-245 | Micro Swanson Reamer Bur | 54 |
| 5091-247 | Micro Wire Pass Bur | 54 |

| Cat. No. | Description | Page No. |
|-----------------|---|-----------------|
| 5091-248 | Micro Wire Pass Bur | 54 |
| 5091-249 | Micro Wire Pass Bur | 54 |
| 5091-252 | Micro Barrel Bur | 55 |
| 5091-254 | Micro Barrel Bur | 55 |
| 5091-260 | Micro Fine Round Diamond Bur | 54 |
| 5091-264 | Micro Fine Round Diamond Bur | 54 |
| 5091-268 | Micro Fine Round Diamond Bur | 54 |
| 5091-270 | Micro Dermabraders – Fine Diamond Bur | 54 |
| 5091-271 | Micro Tapered Cross-cut Fissure Bur | 56 |
| 5091-272 | Micro Tapered Cross-cut Fissure Bur | 56 |
| 5092-203 | Micro Straight Side – Cutting Bur | 55 |
| 5092-204 | Micro Straight Side – Cutting Bur | 55 |
| 5092-206 | Micro Tapered Side – Cutting Bur | 55 |
| 5092-214 | Micro Tapered Side – Cutting Bur | 55 |
| 5092-220 | Micro Round Fluted Bur | 54 |
| 5092-222 | Micro Round Fluted Bur | 54 |
| 5092-224 | Micro Round Fluted Bur | 54 |
| 5092-226 | Micro Round Fluted Bur | 54 |
| 5092-228 | Micro Round Fluted Bur | 54 |
| 5092-230 | Micro Round Fluted Bur | 54 |
| 5092-232 | Micro Round Fluted Bur | 54 |
| 5092-236 | Micro Round Fluted Bur | 54, 55 |
| 5092-238 | Micro Oval Bur | 55 |
| 5092-247 | Micro Wire Pass Bur | 54 |
| 5092-252 | Micro Barrel Bur | 55 |
| 5092-254 | Micro Barrel Bur | 55 |
| 5092-260 | Micro Fine Round Diamond Bur | 54 |
| 5092-262 | Micro Fine Round Diamond Bur | 54 |
| 5092-264 | Micro Fine Round Diamond Bur | 54 |
| 5092-266 | Micro Fine Round Diamond Bur | 54 |
| 5092-268 | Micro Fine Round Diamond Bur | 54 |
| 5092-270 | Micro Dermabraders – Fine Diamond Bur | 54 |
| 5092-271 | Micro Tapered Cross-cut Fissure Bur | 56 |
| 5092-272 | Micro Tapered Cross-cut Fissure Bur | 56 |
| 5092-273 | Micro Tapered Cross-cut Fissure Bur | 56 |
| 5092-283 | Micro Heavy Grit Diamond-Microbur. X-Long Bur | 56 |
| 5092-284 | Micro Heavy Grit Diamond-Microbur. X-Long Bur | 56 |
| 5092-285 | Micro Heavy Grit Diamond-Microbur. X-Long Bur | 56 |
| 5092-286 | Micro Heavy Grit Diamond-Microbur. X-Long Bur | 56 |
| 5092-291 | Micro Cylindrical Bur | 56 |
| 5093-220 | Micro Round Fluted Bur | 54 |
| 5093-221 | Micro Round Fluted Bur | 54 |
| 5093-224 | Micro Round Fluted Bur | 54 |
| 5093-226 | Micro Round Fluted Bur | 54 |
| 5093-228 | Micro Round Fluted Bur | 54 |
| 5093-230 | Micro Round Fluted Bur | 54 |
| 5093-232 | Micro Round Fluted Bur | 54 |
| 5093-236 | Micro Oval Bur | 55 |
| 5093-238 | Micro Oval Bur | 55 |
| 5093-260 | Micro Fine Round Diamond Bur | 54 |
| 5093-262 | Micro Fine Round Diamond Bur | 54 |
| 5093-264 | Micro Fine Round Diamond Bur | 54 |
| 5093-266 | Micro Fine Round Diamond Bur | 54 |
| 5093-282 | Micro Heavy Grit Diamond-Microbur. X-Long Bur | 56 |
| 5093-283 | Micro Heavy Grit Diamond-Microbur. X-Long Bur | 56 |

| Cat. No. | Description | Page No. |
|----------|--|---------------------|
| 5093-284 | Micro Heavy Grit Diamond-Microbur. X-Long Bur | 56 |
| 5093-285 | Micro Heavy Grit Diamond-Microbur. X-Long Bur | 56 |
| 5144-002 | Schrader Coupler | 82 |
| 5271-502 | Hall Large Bone Knee Blade | 19 |
| 5271-561 | Hall Large Bone Knee Blade | 24 |
| 5271-580 | Hall Large Bone Knee Blade | 23 |
| 6020-021 | MicroPower Medium Speed Drill, Removable Lever | 41 |
| 6020-022 | MicroPower Sagittal Saw, Removable Lever | 41 |
| 6020-023 | MicroPower Reciprocating Saw, Removable Lever | 41 |
| 6020-024 | MicroPower Oscillating Saw, Permanently Attached Lever | 41 |
| 6020-025 | Oral Max High Speed Drill, Removable Lever | 41 |
| 6020-026 | MicroPower Orthopedic High Speed Drill, Removable Lever | 41 |
| 6020-260 | Smartguard Irrigator | 42 |
| 6021-021 | MicroPower Medium Speed Drill, Permanently Attached Lever | 41 |
| 6021-022 | MicroPower Sagittal Saw, Permanently Attached Lever | 41 |
| 6021-023 | MicroPower Reciprocating Saw, Permanently Attached Lever | 41 |
| 6021-024 | MicroPower Oscillating Saw, Permanently Attached Lever | 41 |
| 6021-025 | Oral Max High Speed Drill, Permanently Attached Lever | 41 |
| 6021-026 | MicroPower Orthopedic High Speed Drill, Permanently Attached Lever | 41 |
| 7007-03 | Staplizer Cartridge | 78 |
| 7010-03 | Staplizer Cartridge | 78 |
| 7015-03 | Staplizer Cartridge | 78 |
| 7020-001 | Ultrapower High Speed Drill | 61, 83, 84 |
| 7020-002 | Ultrapower Low Speed Drill | 61, 83, 84 |
| 7020-003 | Ultrapower Perforator Drive | 61, 83, 84 |
| 7020-010 | Short Bur Guard (like Midas-X) Red | 61 - 66, 83, 84 |
| 7020-011 | Medium Bur Guard (like Midas-O) Copper | 61 - 66, 83, 84 |
| 7020-012 | Long Bur Guard (like Midas-M/B) Mustard | 61 - 66, 73, 83, 84 |
| 7020-013 | X-Long Bur Guard (like Midas-AM/A) Lime | 61 - 66, 83, 84 |
| 7020-014 | Short Revision Extension (like Midas TU) Teal | 61 - 66, 83, 84 |
| 7020-015 | Medium Revision Extension (like Midas-R) Purple | 61 - 63, 65, 83, 84 |
| 7020-016 | Long Revision Extension (like Midas RX) Blue | 61, 62, 65, 83, 84 |
| 7020-017 | Short Bur Guard (like Midas B-5) Black | 61, 67, 83, 84 |
| 7020-018 | Medium Bur Guard (like Midas B-1) Green | 61, 67, 83, 84 |
| 7020-019 | Long Bur Guard (like Midas S-1) Brown | 61, 73, 83, 84 |
| 7020-022 | 90 degree Angle Attachment (like Midas AF/BF) | 61, 83, 84 |
| 7020-023 | 20 degree Long Keyless Attachment | 61, 83, 84 |
| 7020-024 | 20 degree Angle X-Long Keyless Attachment | 83, 84 |
| 7020-040 | Key Wrench, 2 per box | 83, 84 |
| 7020-041 | Attachment Spray | 61, 83, 84 |
| 7020-045 | Ultrapower Footswitch | 67, 83, 84 |
| 7020-046 | Bur Cabinet for Neuro Burs | 64, 66, 84 |
| 7021-012 | UltraPower Side Cutting Bur | 62, 64 |
| 7021-013 | UltraPower Side Cutting Bur | 62 |
| 7021-015 | UltraPower Side Cutting Bur | 62 |
| 7021-024 | UltraPower Round Fluted Bur | 62 |
| 7021-025 | UltraPower Round Fluted Bur | 62 |
| 7021-026 | UltraPower Round Fluted Bur | 62 |
| 7021-027 | UltraPower Round Fluted Bur | 62 |
| 7021-028 | UltraPower Round Fluted Bur | 62 |
| 7021-029 | UltraPower Round Fluted Bur | 62 |
| 7021-030 | UltraPower Round Fluted Bur | 62 |
| 7021-031 | UltraPower Round Fluted Bur | 62 |
| 7021-032 | UltraPower Round Fluted Bur | 64 |
| 7021-033 | UltraPower Round Fluted Bur | 64 |

| Cat. No. | Description | Page No. |
|-----------------|---|-----------------|
| 7021-034 | UltraPower Round Fluted Bur | 66 |
| 7021-036 | UltraPower Fluted Cylindrical Bur | 66 |
| 7021-037 | UltraPower Fluted Cylindrical Bur | 66 |
| 7021-040 | UltraPower Wire Pass Bur | 64 |
| 7021-041 | UltraPower Wire Pass Bur | 65 |
| 7021-042 | UltraPower Wire Pass Bur | 62 |
| 7021-043 | UltraPower Side Cutting Bur | 62 |
| 7021-051 | UltraPower Trepine Bur | 62 |
| 7021-062 | UltraPower Fine Round Diamond Bur | 62 |
| 7021-063 | UltraPower Fine Round Diamond Bur | 62 |
| 7021-064 | UltraPower Fine Round Diamond Bur | 63 |
| 7021-065 | UltraPower Fine Round Diamond Bur | 63 |
| 7021-066 | UltraPower Fine Round Diamond Bur | 63 |
| 7021-074 | UltraPower Coarse Round Diamond Bur | 65 |
| 7021-075 | UltraPower Coarse Round Diamond Bur | 65 |
| 7021-077 | UltraPower Coarse Round Diamond Bur | 66 |
| 7021-081 | UltraPower Fluted Acorn Bur | 66 |
| 7021-083 | UltraPower Fluted Acorn Bur | 66 |
| 7021-092 | UltraPower Fine Diamond Wheel for Metal Cutting Bur | 66 |
| 7021-094 | UltraPower Carbide Metal Cutting Bur | 64 |
| 7021-095 | UltraPower Oval Fluted Bur | 64 |
| 7021-096 | UltraPower Oval Fluted Bur | 64 |
| 7021-112 | UltraPower Side Cutting Bur | 64 |
| 7021-113 | UltraPower Side Cutting Bur | 64 |
| 7021-114 | UltraPower Side Cutting Bur | 64 |
| 7021-115 | UltraPower Side Cutting Bur | 62 |
| 7021-116 | UltraPower Side Cutting Bur | 62 |
| 7021-119 | UltraPower Side Cutting Bur | 62 |
| 7021-122 | UltraPower Round Fluted Bur | 62 |
| 7021-123 | UltraPower Round Fluted Bur | 62 |
| 7021-124 | UltraPower Round Fluted Bur | 62 |
| 7021-125 | UltraPower Round Fluted Bur | 62 |
| 7021-126 | UltraPower Round Fluted Bur | 62 |
| 7021-127 | UltraPower Round Fluted Bur | 62 |
| 7021-128 | UltraPower Round Fluted Bur | 62 |
| 7021-129 | UltraPower Round Fluted Bur | 62 |
| 7021-130 | UltraPower Round Fluted Bur | 62 |
| 7021-131 | UltraPower Round Fluted Bur | 62 |
| 7021-132 | UltraPower Round Fluted Bur | 64 |
| 7021-133 | UltraPower Round Fluted Bur | 64 |
| 7021-134 | UltraPower Round Fluted Bur | 66 |
| 7021-136 | UltraPower Fluted Cylindrical Bur | 66 |
| 7021-137 | UltraPower Fluted Cylindrical Bur | 66 |
| 7021-140 | UltraPower Wire Pass Bur | 66 |
| 7021-141 | UltraPower Wire Pass Bur | 66 |
| 7021-141-35 | UltraPower Fluted Frustrum Bur – Depth Limiting | 66 |
| 7021-141-50 | UltraPower Fluted Frustrum Bur – Depth Limiting | 64 |
| 7021-141-90 | UltraPower Fluted Frustrum Bur – Depth Limiting | 66 |
| 7021-142 | UltraPower Wire Pass Bur | 62 |
| 7021-143 | UltraPower Side Cutting Bur | 62 |
| 7021-145-70 | UltraPower Fluted Frustrum Bur – Depth Limiting | 62 |
| 7021-161 | UltraPower Fine Round Diamond Bur | 62 |
| 7021-162 | UltraPower Fine Round Diamond Bur | 62 |
| 7021-163 | UltraPower Fine Round Diamond Bur | 62 |
| 7021-164 | UltraPower Fine Round Diamond Bur | 62 |

| Cat. No. | Description | Page No. |
|-----------------|-------------------------------------|-----------------|
| 7021-165 | UltraPower Fine Round Diamond Bur | 63 |
| 7021-166 | UltraPower Fine Round Diamond Bur | 63 |
| 7021-167 | UltraPower Fine Round Diamond Bur | 63 |
| 7021-171 | UltraPower Coarse Round Diamond Bur | 63 |
| 7021-172 | UltraPower Coarse Round Diamond Bur | 63 |
| 7021-173 | UltraPower Coarse Round Diamond Bur | 63 |
| 7021-174 | UltraPower Coarse Round Diamond Bur | 63 |
| 7021-175 | UltraPower Coarse Round Diamond Bur | 65 |
| 7021-176 | UltraPower Coarse Round Diamond Bur | 65 |
| 7021-177 | UltraPower Coarse Round Diamond Bur | 65 |
| 7021-181 | UltraPower Fluted Acorn Bur | 66 |
| 7021-182 | UltraPower Fluted Acorn Bur | 66 |
| 7021-183 | UltraPower Fluted Acorn Bur | 63 |
| 7021-195 | UltraPower Oval Fluted Bur | 63 |
| 7021-196 | UltraPower Oval Fluted Bur | 63 |
| 7021-202 | UltraPower Side Cutting Bur | 63 |
| 7021-206 | UltraPower Side Cutting Bur | 64 |
| 7021-207 | UltraPower Side Cutting Bur | 64 |
| 7021-210 | UltraPower Side Cutting Bur | 62 |
| 7021-214 | UltraPower Side Cutting Bur | 62 |
| 7021-218 | UltraPower Side Cutting Bur | 62 |
| 7021-220 | UltraPower Round Fluted Bur | 62 |
| 7021-222 | UltraPower Round Fluted Bur | 62 |
| 7021-223 | UltraPower Round Fluted Bur | 62 |
| 7021-224 | UltraPower Round Fluted Bur | 62 |
| 7021-225 | UltraPower Round Fluted Bur | 62 |
| 7021-226 | UltraPower Round Fluted Bur | 62 |
| 7021-227 | UltraPower Round Fluted Bur | 62 |
| 7021-228 | UltraPower Round Fluted Bur | 62 |
| 7021-229 | UltraPower Round Fluted Bur | 62 |
| 7021-230 | UltraPower Round Fluted Bur | 62 |
| 7021-231 | UltraPower Round Fluted Bur | 64 |
| 7021-232 | UltraPower Round Fluted Bur | 64 |
| 7021-233 | UltraPower Round Fluted Bur | 64 |
| 7021-235 | UltraPower Fluted Cylindrical Bur | 64 |
| 7021-236 | UltraPower Fluted Cylindrical Bur | 65 |
| 7021-237 | UltraPower Fluted Cylindrical Bur | 65 |
| 7021-243 | UltraPower Side Cutting Bur | 65 |
| 7021-250 | UltraPower Trephine Bur | 65 |
| 7021-252 | UltraPower Trephine Bur | 62 |
| 7021-253 | UltraPower Trephine Bur | 62 |
| 7021-255 | UltraPower Trephine Bur | 62 |
| 7021-261 | UltraPower Fine Round Diamond Bur | 62 |
| 7021-262 | UltraPower Fine Round Diamond Bur | 62 |
| 7021-263 | UltraPower Fine Round Diamond Bur | 62 |
| 7021-264 | UltraPower Fine Round Diamond Bur | 62 |
| 7021-265 | UltraPower Fine Round Diamond Bur | 63 |
| 7021-266 | UltraPower Fine Round Diamond Bur | 63 |
| 7021-267 | UltraPower Fine Round Diamond Bur | 63 |
| 7021-272 | UltraPower Coarse Round Diamond Bur | 63 |
| 7021-273 | UltraPower Coarse Round Diamond Bur | 63 |
| 7021-274 | UltraPower Coarse Round Diamond Bur | 63 |
| 7021-275 | UltraPower Coarse Round Diamond Bur | 65 |
| 7021-276 | UltraPower Coarse Round Diamond Bur | 65 |
| 7021-277 | UltraPower Coarse Round Diamond Bur | 65 |

| Cat. No. | Description | Page No. |
|-----------------|---|-----------------|
| 7021-279 | UltraPower Fine Diamond Cylindrical Bur | 65 |
| 7021-280 | UltraPower Fluted Acorn Bur | 65 |
| 7021-281 | UltraPower Fluted Acorn Bur | 66 |
| 7021-282 | UltraPower Fluted Acorn Bur | 66 |
| 7021-283 | UltraPower Fluted Acorn Bur | 66 |
| 7021-292 | UltraPower Fine Diamond Wheel for Metal Cutting Bur | 66 |
| 7021-294 | UltraPower Carbide Metal Cutting Bur | 66 |
| 7021-295 | UltraPower Oval Fluted Bur | 64 |
| 7021-296 | UltraPower Oval Fluted Bur | 63 |
| 7021-297 | UltraPower Carbide Metal Cutting Bur | 63 |
| 7021-301 | UltraPower Side Cutting Bur | 63 |
| 7021-302 | UltraPower Side Cutting Bur | 63 |
| 7021-303 | UltraPower Side Cutting Bur | 63 |
| 7021-305 | UltraPower Side Cutting Bur | 64 |
| 7021-309 | UltraPower Side Cutting Bur | 64 |
| 7021-310 | UltraPower Side Cutting Bur | 64 |
| 7021-314 | UltraPower Side Cutting Bur | 62 |
| 7021-315 | UltraPower Side Cutting Bur | 62 |
| 7021-318 | UltraPower Side Cutting Bur | 62 |
| 7021-322 | UltraPower Round Fluted Bur | 62 |
| 7021-323 | UltraPower Round Fluted Bur | 62 |
| 7021-324 | UltraPower Round Fluted Bur | 62 |
| 7021-325 | UltraPower Round Fluted Bur | 62 |
| 7021-326 | UltraPower Round Fluted Bur | 62 |
| 7021-327 | UltraPower Round Fluted Bur | 62 |
| 7021-328 | UltraPower Round Fluted Bur | 62 |
| 7021-329 | UltraPower Round Fluted Bur | 62 |
| 7021-331 | UltraPower Round Fluted Bur | 64 |
| 7021-332 | UltraPower Round Fluted Bur | 64 |
| 7021-333 | UltraPower Round Fluted Bur | 64 |
| 7021-335 | UltraPower Fluted Cylindrical Bur | 64 |
| 7021-336 | UltraPower Fluted Cylindrical Bur | 62 |
| 7021-337 | UltraPower Fluted Cylindrical Bur | 62 |
| 7021-338 | UltraPower Fluted Cylindrical Bur | 62 |
| 7021-361 | UltraPower Fine Round Diamond Bur | 62 |
| 7021-362 | UltraPower Fine Round Diamond Bur | 62 |
| 7021-363 | UltraPower Fine Round Diamond Bur | 62 |
| 7021-364 | UltraPower Fine Round Diamond Bur | 62 |
| 7021-365 | UltraPower Fine Round Diamond Bur | 63 |
| 7021-366 | UltraPower Fine Round Diamond Bur | 63 |
| 7021-367 | UltraPower Fine Round Diamond Bur | 63 |
| 7021-371 | UltraPower Coarse Round Diamond Bur | 63 |
| 7021-372 | UltraPower Coarse Round Diamond Bur | 63 |
| 7021-373 | UltraPower Coarse Round Diamond Bur | 63 |
| 7021-374 | UltraPower Coarse Round Diamond Bur | 63 |
| 7021-375 | UltraPower Coarse Round Diamond Bur | 65 |
| 7021-376 | UltraPower Coarse Round Diamond Bur | 65 |
| 7021-377 | UltraPower Coarse Round Diamond Bur | 65 |
| 7021-378 | UltraPower Fine Diamond Cylindrical Bur | 65 |
| 7021-379 | UltraPower Fine Diamond Cylindrical Bur | 65 |
| 7021-380 | UltraPower Fluted Acorn Bur | 65 |
| 7021-381 | UltraPower Fluted Acorn Bur | 66 |
| 7021-382 | UltraPower Fluted Acorn Bur | 66 |
| 7021-383 | UltraPower Fluted Acorn Bur | 66 |
| 7021-391 | UltraPower Fluted Frustrum Bur | 66 |

| Cat. No. | Description | Page No. |
|-----------------|---|-----------------|
| 7021-392 | UltraPower Fine Diamond Wheel for Metal Cutting Bur | 63 |
| 7021-395 | UltraPower Oval Fluted Bur | 63 |
| 7021-396 | UltraPower Oval Fluted Bur | 62 |
| 7021-408 | UltraPower Side Cutting Bur | 62 |
| 7021-409 | UltraPower Side Cutting Bur | 63 |
| 7021-426 | UltraPower Round Fluted Bur | 62 |
| 7021-427 | UltraPower Round Fluted Bur | 62 |
| 7021-427 | UltraPower Side Cutting Bur | 62 |
| 7021-428 | UltraPower Round Fluted Bur | 62 |
| 7021-429 | UltraPower Round Fluted Bur | 62 |
| 7021-431 | UltraPower Round Fluted Bur | 64 |
| 7021-432 | UltraPower Round Fluted Bur | 63 |
| 7021-433 | UltraPower Round Fluted Bur | 65 |
| 7021-437 | UltraPower Fluted Cylindrical Bur | 65 |
| 7021-474 | UltraPower Coarse Round Diamond Bur | 66 |
| 7021-482 | UltraPower Fluted Acorn Bur | 63 |
| 7021-483 | UltraPower Fluted Acorn Bur | 62 |
| 7021-492 | UltraPower Fine Diamond Wheel for Metal Cutting Bur | 62 |
| 7021-509 | UltraPower Side Cutting Bur | 62 |
| 7021-526 | UltraPower Round Fluted Bur | 62 |
| 7021-528 | UltraPower Round Fluted Bur | 62 |
| 7021-529 | UltraPower Round Fluted Bur | 62 |
| 7021-531 | UltraPower Round Fluted Bur | 65 |
| 7021-532 | UltraPower Round Fluted Bur | 65 |
| 7021-533 | UltraPower Round Fluted Bur | 62 |
| 7021-581 | UltraPower Fluted Acorn Bur | 62 |
| 7021-583 | UltraPower Fluted Acorn Bur | 62 |
| 7021-631 | UltraPower Round Fluted Bur | 65 |
| 7021-632 | UltraPower Round Fluted Bur | 65 |
| 7021-633 | UltraPower Round Fluted Bur | 64 |
| 7021-681 | UltraPower Fluted Acorn Bur | 73 |
| 7021-683 | UltraPower Fluted Acorn Bur | 64 |
| 7021-713 | UltraPower Side Cutting Bur | 64, 73 |
| 7021-815 | UltraPower Side Cutting Bur | 73 |
| 7021-917 | UltraPower Side Cutting Bur | 78 |
| 7021-960 | Helical Bur for E9010 Drill | 78 |
| 7307-03 | Staplizer Cartridge | 78 |
| 7310-03 | Staplizer Cartridge | 78 |
| 7315-03 | Staplizer Cartridge | 78 |
| 7320-03 | Staplizer Cartridge | 78 |
| 7610-03 | Staplizer Cartridge | 78 |
| 7615-03 | Staplizer Cartridge | 78 |
| 7620-03 | Staplizer Cartridge | 78 |
| 7625-03 | Staplizer Cartridge | 82 |
| 7707-03 | Staplizer Cartridge | 68 |
| 7710-03 | Staplizer Cartridge | 69 |
| A201 | 10' (3.05m) Hose for Staplizer® Handpiece | 48 |
| A9350 | Rhinotec Cuda Blade 4.2mm, Bendable to 45°, 10.5cm Working Length, 6/Box | 48 |
| A9360 | Rhinotec Gator Blade 4.2mm, Bendable to 45°, 10.5cm Working Length, 6/Box | 48 |
| C8803 | Micro ACL Sagittal Saw Blade | 81 |
| C8804 | Micro ACL Sagittal Saw Blade | 71 |
| C8806 | Micro ACL Sagittal Saw Blade | 71 |
| C9863 | 3-Pedal Footswitch | 68 |
| C9911 | Rhinotec Spherical Bur, 2.9mm, Hooded, 7.6cm Working Length, 6/ Box | 68 |
| C9912 | Rhinotec Spherical Bur, 3.5mm, Hooded, 7.6cm Working Length, 6/Box | 68 |

| Cat. No. | Description | Page No. |
|----------|---|----------|
| C9950 | Rhinotec Cuda Blade 2.0mm, 7.6cm Working Length, 6/Box | 69 |
| C9951 | Rhinotec Cuda Blade 2.9mm, 7.6cm Working Length, 6/Box | 69 |
| C9952 | Rhinotec Cuda Blade 3.5mm, 7.6cm Working Length, 6/Box | 69 |
| C9960 | Rhinotec Gator Blade 2.0mm, 7.6cm Working Length, 6/Box | 70 |
| C9961 | Rhinotec Gator Blade 2.9mm, 7.6cm Working Length, 6/Box | 70 |
| C9962 | Rhinotec Gator Blade 3.5mm, 7.6cm Working Length, 6/Box | 80 |
| C9990 | Rhinotec Vortex Router 2.9mm, Hooded, 7.6cm Working Length, 6/Box | 80 |
| C9991 | Rhinotec Vortex Router 3.5mm, Hooded, 7.6cm Working Length, 6/Box | 80 |
| D3000 | Advantage Console | 73 |
| D4000 | D4000 Console | 73 |
| D4000A | D4000 Console with Irrigation | 73 |
| E4110 | Wirepass E Bur | 73 |
| E4115 | Wirepass E Bur | 73 |
| E4120 | Wirepass E Bur | 73 |
| E4208 | E9010 Side Cutting Bur | 72 |
| E4217 | E9010 Lindemann Bur | 72 |
| E4220 | E9010 Side Cutting Bur | 72 |
| E5050 | Coarse Round Diamond E Bur | 72 |
| E5120 | Coarse Round Diamond E Bur | 72 |
| E5130 | Coarse Round Diamond E Bur | 72 |
| E5140 | Coarse Round Diamond E Bur | 72 |
| E5150 | Coarse Round Diamond E Bur | 72 |
| E5160 | Coarse Round Diamond E Bur | 72 |
| E5170 | Coarse Round Diamond E Bur | 72 |
| E5210 | Coarse Round Diamond E Bur | 72 |
| E5215 | Coarse Round Diamond E Bur | 72 |
| E5220 | Coarse Round Diamond E Bur | 72 |
| E5225 | Coarse Round Diamond E Bur | 72 |
| E5230 | Coarse Round Diamond E Bur | 72 |
| E5240 | Coarse Round Diamond E Bur | 72 |
| E6040 | Fine Round Diamond E Bur | 72 |
| E6105 | Fine Round Diamond E Bur | 72 |
| E6110 | Fine Round Diamond E Bur | 72 |
| E6115 | Fine Round Diamond E Bur | 72 |
| E6120 | Fine Round Diamond E Bur | 72 |
| E6125 | Fine Round Diamond E Bur | 72 |
| E6130 | Fine Round Diamond E Bur | 72 |
| E6140 | Fine Round Diamond E Bur | 72 |
| E6150 | Fine Round Diamond E Bur | 72 |
| E6160 | Fine Round Diamond E Bur | 72 |
| E6205 | Fine Round Diamond E Bur | 72 |
| E6207 | Fine Round Diamond E Bur | 72 |
| E6210 | Fine Round Diamond E Bur | 72 |
| E6215 | Fine Round Diamond E Bur | 72 |
| E6220 | Fine Round Diamond E Bur | 72 |
| E6225 | Fine Round Diamond E Bur | 72 |
| E6230 | Fine Round Diamond E Bur | 72 |
| E6240 | Fine Round Diamond E Bur | 72 |
| E6250 | Fine Round Diamond E Bur | 72 |
| E8007 | Round Fluted E Bur | 72 |
| E8010 | Round Fluted E Bur | 72 |
| E8015 | Round Fluted E Bur | 72 |
| E8020 | Round Fluted E Bur | 72 |
| E8025 | Round Fluted E Bur | 72 |
| E8030LSO | LSO Round Fluted E Bur | 72 |

| Cat. No. | Description | Page No. |
|-----------------|--|-----------------|
| E8040LSO | LSO Round Fluted E Bur | 72 |
| E8050LSO | LSO Round Fluted E Bur | 72 |
| E8065LSO | LSO Round Fluted E Bur | 72 |
| E8105 | Round Fluted E Bur | 72 |
| E8110 | Round Fluted E Bur | 72 |
| E8115 | Round Fluted E Bur | 72 |
| E8120 | Round Fluted E Bur | 72 |
| E8125 | Round Fluted E Bur | 72 |
| E8130LSO | LSO Round Fluted E Bur | 72 |
| E8140LSO | LSO Round Fluted E Bur | 72 |
| E8150LSO | LSO Round Fluted E Bur | 72 |
| E8165LSO | LSO Round Fluted E Bur | 72 |
| E8205 | Round Fluted E Bur | 72 |
| E8207 | Round Fluted E Bur | 72 |
| E8210 | Round Fluted E Bur | 72 |
| E8215 | Round Fluted E Bur | 72 |
| E8220 | Round Fluted E Bur | 72 |
| E8225 | Round Fluted E Bur | 72 |
| E8230LSO | LSO Round Fluted E Bur | 80 |
| E8240LSO | LSO Round Fluted E Bur | 67 |
| E8265LSO | LSO Round Fluted E Bur | 67 |
| E9000 | E9000 Console | 67 |
| E9005 | High Speed Shaver | 73 |
| E9010 | CoolFlex® High Speed Drill | 73 |
| E9011-1 | Medium Bur Guard for E9010 Drill | 67, 72, 73 |
| E9011-2 | Long Bur Guard for E9010 Drill | 67, 72, 73 |
| E9011-3 | X-Long Bur Guard for E9010 Drill | 67 |
| E9011-7 | Short Neuro Guard for E9010 Drill | 67, 73 |
| E9011-8 | Medium Neuro Guard for E9010 Drill | 67 |
| E9011-9 | Long Neuro Guard for E9010 Drill | 67 |
| E9012 | Locking Collar for E9010 Drill | 67 |
| E9015 | Cranial Perforator Drive | 68 |
| E9315 | DeClogger for removing tissue and bone from shaver blades and burs | 68 |
| E9323 | Bur Rack, Holds up to 20 burs for E9010 Drill | 69 |
| E9350 | Rhinotec Cuda Blade 4.2mm, Bendable to 30°, Irrigated, 10.5cm Working Length, 6/Box | 69 |
| E9351 | Rhinotec Cuda Blade 3.7mm, Bendable to 30°, Irrigated, 10.5cm Working Length, 6/Box | 69 |
| E9360 | Rhinotec Gator Blade 4.2mm, Bendable to 30°, Irrigated, 10.5cm Working Length, 6/Box | 67 |
| E9361 | Rhinotec Gator Blade 3.7mm, Bendable to 30°, Irrigated, 10.5cm Working Length, 6/Box | 67 |
| E9363 | Laryngeal Blade 3.7mm, Bendable to 45°, 20.0cm Working Length, 6/Box | 67 |
| E9414 | Drill Tubing for E9010 Drill without irrigation tip | 67 |
| E9415A | Drill Tubing for E9010 Drill with irrigation tip | 43 |
| E9416 | 4.2mm FESS Irrigation Tubing Set for E9005 Shaver | 54 |
| E9417 | 3.7mm FESS Irrigation Tubing Set for E9005 Shaver (Not Shown) | 55 |
| E9418 | Irrigation Tubing Set | 55 |
| L10D | Micro Fine Round Diamond Bur | 55 |
| L12T | Micro Tapered Side – Cutting Bur | 54 |
| L13S | Micro Straight Side – Cutting Bur | 55 |
| L17S | Micro Straight Side – Cutting Bur | 54 |
| L18R | Micro Round Fluted Bur | 8 |
| L20T | Micro Tapered Side – Cutting Bur | 8 |
| L23R | Micro Round Fluted Bur | 8 |
| L3000 | Hall Lithium Charger | 55 |
| L3000LG | Hall Large Lithium Battery, 13.2 Volt | 56 |
| L300SM | Hall Small Lithium Battery, 13.2 Volt | 55 |
| L40B | Micro Oval Bur | 54 |

| Cat. No. | Description | Page No. |
|-----------------|---|-----------------|
| L45C | Micro Cone Bur | 82 |
| L55B | Micro Oval Bur | 55 |
| L60R | Micro Round Fluted Bur | 55 |
| M105A | Blitz Instrument Cleaner (Use with Staplizer Handpiece) | 55 |
| M10S | Micro Straight Side – Cutting Bur | 55 |
| M12T | Micro Tapered Side – Cutting Bur | 55 |
| M13S | Micro Straight Side – Cutting Bur | 82 |
| M15S | Micro Straight Side – Cutting Bur | 82 |
| M17S | Micro Straight Side – Cutting Bur | 55 |
| M207 | Regulator, Single Connection | 82 |
| M208 | Regulator, Dual Connection | 82 |
| M20T | Micro Tapered Side – Cutting Bur | 55 |
| M317 | Instrument Lubricant for Staplizer | 56 |
| M322 | DISS to Schrader Adapter | 55 |
| M40B | Micro Oval Bur | 54 |
| M45C | Micro Cone Bur | 54 |
| M55B | Micro Oval Bur | 81 |
| M60D | Micro Fine Round Diamond Bur | 68 |
| M60R | Micro Round Fluted Bur | 68 |
| MC5057 | Handpiece Cord | 69 |
| N9150 | Lynx Blade 4.2mm, Irrigated, 10.5cm Working Length, 6/Box | 69 |
| N9210 | Rhinotec Cuda Blade 4.2mm, Irrigated, 10.5cm Working Length, 6/Box | 69 |
| N9220 | Rhinotec Gator Blade 4.2mm, Irrigated, 10.5cm Working Length, 6/Box | 68 |
| N9320 | Head & Neck Blade 3.5mm, 7.0cm Working Length, 6/Box | 70 |
| N9321 | Head & Neck Blade 4.2mm, 11.5cm Working Length, 6/Box | 71 |
| N9330 | MicroXcisor Blade 4.2mm, Irrigated, 10.5cm Working Length, 6/Box | 71 |
| N9375 | Curved Vortex Router 4.5mm, 45° Pre-Bent, 11.5cm Working Length, 6/Box | 71 |
| N9380 | Rhinotec Spherical Bur, 4.5mm, Hooded, 10.8cm Working Length, 6/Box | 70 |
| N9382 | Rhinotec Spherical Bur, 3.5mm, Unhooded, 7.6cm Working Length, 6/Box | 13 |
| N9385 | Rhinotec Spherical Diamond Bur, 3.5mm, Hooded, 10.8cm Working Length, 6/Box | 13 |
| N9390 | Otolaryngology Bur 4.0mm, Hooded, 10.8cm Working Length, 6/Box | 13 |
| PR01540 | Drill-Ream Attachment, AO | 13 |
| PR01541 | Drill-Ream Attachment, 1/4" (6.35mm) Chuck | 80 |
| PR01547 | Drill-Ream Attachment, Zimmer/Hudson | 13 |
| PR01548 | Drill-Ream Attachment, DePuy/Hudson | 13 |
| PR02000 | PowerPro Console | 13 |
| PR02029 | AO/Trinkle | 13 |
| PR02030 | 5/32" (4.0mm) Jacobs Chuck, with Chuck Key | 13 |
| PR02033 | High Speed Drill Attachment | 13 |
| PR02038 | Small AO—Low Profile | 13 |
| PR02039 | Mini AO | 13 |
| PR02040 | 3:1 Large AO Reamer | 13 |
| PR02041 | 1/4" (6.35mm) Jacobs Chuck | 13 |
| PR02042 | 3:1 1/4" High Torque Jacobs Chuck | 13 |
| PR02043 | Sagittal Saw Attachment | 13 |
| PR02046 | Zimmer/Hudson | 13 |
| PR02047 | 3:1 Zimmer/Hudson Reamer | 13 |
| PR02060 | 3:1 Aesculap Reamer | 13 |
| PR02065 | 3:1 Hudson Reamer (DePuy) | 13 |
| PR02070 | Large AO | 13 |
| PR02075 | Standard Hudson (DePuy) | 13 |
| PR02080 | 3:1 DHS Reamer | 13 |
| PR02138 | Small AO—One Handed Operation | 13 |
| PR02250 | 1/4" Keyless Chuck | 8 |
| PR02329 | 3:1 Trinkle Reamer | 8 |

| Cat. No. | Description | Page No. |
|-----------------|---|-----------------|
| PRO2514 | Radiolucent Drive Adaptor | 8 |
| PRO3010 | Large NiCad Battery, 9.6 Volt | 9 |
| PRO3011 | X-Large NiCad Battery, 12 Volt | 9 |
| PRO3020 | Small NiCad Battery, 12 Volt | 9 |
| PRO3110 | Battery Case for PRO3115 | 9 |
| PRO3115 | Large NiMH Sterile Transfer Battery, 9.6 Volt | 9 |
| PRO3130 | Transfer Shroud for PRO3110 | 9 |
| PRO3135 | Charging Platform for PRO3115 | 9 |
| PRO3520 | Small NiMH Sterile Transfer Battery, 12 Volt | 9 |
| PRO3521 | Battery Case for PRO3520 | 8 |
| PRO3531 | Transfer Shroud for PRO3521 | 44 |
| PRO3535 | Charging Platform for PRO3520 | 13 |
| PRO3600 | NiCad Battery Charger | 13 |
| PRO6000 | Small Bone Tray | 13 |
| PRO6040 | 5:1 Large AO Reamer | 13 |
| PRO6042 | 5:1 1/4" High Torque Jacobs Chuck | 13 |
| PRO6045 | Reciprocating Saw Attachment for PRO6100, PRO6150, PRO6200M, & PRO6202M | 13 |
| PRO6047 | 5:1 Zimmer/Hudson Reamer | 13 |
| PRO6048 | 5:1 Hudson Reamer(DePuy) | 10 |
| PRO6050 | 1/8" Keyless Chuck | 10 |
| PRO6060 | 5:1 Aesculap Reamer | 12 |
| PRO6100 | Single Trigger Modular Handpiece | 10 |
| PRO6125 | Oscillating Saw | 12 |
| PRO6128 | Wire Driver, Range: 0.7 – 1.6mm (0.028 – 0.062") | 11 |
| PRO6135 | Reciprocating Saw | 11 |
| PRO6140 | Pin Driver, Range: 1.8 – 4.0mm (0.071 – 0.157") | 11 |
| PRO6150 | Single Trigger Modular Handpiece | 7 |
| PRO6175 | Oscillating Saw | 7 |
| PRO6185 | Reciprocating Saw | 12 |
| PRO6200M | Single Trigger Modular Handpiece | 12 |
| PRO6202M | 2-Trigger Modular Handpiece | 7 |
| PRO6228 | Wire Driver Range: 0.7 – 1.6mm (0.028 – 0.062") | 7 |
| PRO6240 | Pin Driver Range: 1.8 – 4.0mm (0.071 – 0.157") | 57 |
| PRO6350M | Oscillating Saw | 40 |
| PRO6400M | Reciprocating Saw | 40 |
| PRO6450M | MPower 2 Battery Sternum Saw | 14 |
| PRO7000DE | Oral Max Elite High Speed Drill | 14 |
| PRO7000SE | MicroPower+ Orthopedic High Speed Drill | 14 |
| PRO7000T | 3/4 Size Inner Tray, Full Set | 44 |
| PRO7001T | 1/2 Size Inner Tray, Drill Set | 13 |
| PRO7002T | 1/2 Size Inner Tray, Saw Set | 6 |
| PRO7003T | 1/2 Size Inner Tray, Small Bone Set | 40 |
| PRO7020 | Multipurpose High Speed | 6 |
| PRO7100B | Hall 50 1-Trigger Modular Handpiece | 40 |
| PRO7100SE | MicroPower+ Medium Speed Drill | 6 |
| PRO7200B | Hall 50 2-Trigger Modular Handpiece | 40 |
| PRO7200SE | MicroPower+ Sagittal Saw | 6 |
| PRO7300B | Hall 50 Oscillating Saw Handpiece | 40 |
| PRO7300SE | MicroPower+ Oscillating Saw | 57 |
| PRO7400B | Hall 50 Reciprocating Saw Handpiece | 18 |
| PRO7400SE | MicroPower+ Reciprocating Saw | 18 |
| PRO7450B | Hall 50 Sternum Saw Handpiece | 18 |
| STK130-089-90 | Stryker Replacement Blade | 18 |
| STK130-119-90 | Stryker Replacement Blade | 18 |
| STK130-127-90 | Stryker Replacement Blade | 18 |

| Cat. No. | Description | Page No. |
|-----------------|--|-----------------|
| STK190-089-90 | Stryker Replacement Blade | 18 |
| STK190-089-90 | Stryker Replacement Blade | 18 |
| STK190-127-05 | Stryker Replacement Blade | 18 |
| STK190-127-90 | Stryker Replacement Blade | 18 |
| STK190-137-90 | Stryker Replacement Blade | 18 |
| STK193-137-90 | Stryker Replacement Blade | 18 |
| STK193-137-90 | Stryker Replacement Blade | 18 |
| STK250-100-90 | Stryker Replacement Blade | 18 |
| STK250-119-90 | Stryker Replacement Blade | 18 |
| STK250-127-90 | Stryker Replacement Blade | 15 |
| STK250-137-90 | Stryker Replacement Blade | 15 |
| STK250-147-90 | Stryker Replacement Blade | 15 |
| TN130-089-90 | M-Class Blade | 15 |
| TN130-100-90 | M-Class Blade | 15 |
| TN130-107-90 | M-Class Blade | 15 |
| TN130-119-90 | M-Class Blade | 15 |
| TN130-127-90 | M-Class Blade | 15 |
| TN130-137-90 | M-Class Blade | 15 |
| TN130-147-90 | M-Class Blade | 15 |
| TN190-089-90 | M-Class Blade | 15 |
| TN190-100-90 | M-Class Blade | 15 |
| TN190-107-90 | M-Class Blade | 15 |
| TN190-119-05 | M-Class Blade | 15 |
| TN190-119-90 | M-Class Blade | 15 |
| TN190-127-05 | M-Class Blade | 15 |
| TN190-127-90 | M-Class Blade | 15 |
| TN190-137-05 | M-Class Blade | 15 |
| TN190-137-90 | M-Class Blade | 15 |
| TN190-147-90 | M-Class Blade | 15 |
| TN193-119-90 | M-Class Blade | 15 |
| TN193-127-90 | M-Class Blade | 15 |
| TN193-137-90 | M-Class Blade | 15 |
| TN250-089-90 | M-Class Blade | 15 |
| TN250-100-90 | M-Class Blade | 15 |
| TN250-107-90 | M-Class Blade | 15 |
| TN250-119-90 | M-Class Blade | 15 |
| TN250-127-90 | M-Class Blade | 14 |
| TN250-137-90 | M-Class Blade | 44 |
| TN250-147-90 | M-Class Blade | 14 |
| TR12R | 1/2 Size Rigid Sterilization Container | 16 |
| TR34R | 3/4 Size Rigid Sterilization Container | 16 |
| V130-089-90 | Hall Classic Blade | 16 |
| V130-100-90 | Hall Classic Blade | 16 |
| V130-107-90 | Hall Classic Blade | 16 |
| V130-119-90 | Hall Classic Blade | 16 |
| V130-127-90 | Hall Classic Blade | 16 |
| V130-137-90 | Hall Classic Blade | 16 |
| V130-147-90 | Hall Classic Blade | 16 |
| V190-089-05 | Hall Classic Blade | 16 |
| V190-089-90 | Hall Classic Blade | 16 |
| V190-100-05 | Hall Classic Blade | 16 |
| V190-100-90 | Hall Classic Blade | 16 |
| V190-107-05 | Hall Classic Blade | 16 |
| V190-107-90 | Hall Classic Blade | 16 |
| V190-119-05 | Hall Classic Blade | 16 |

| Cat. No. | Description | Page No. |
|-----------------|------------------------------|-----------------|
| V190-119-90 | Hall Classic Blade | 16 |
| V190-127-05 | Hall Classic Blade | 16 |
| V190-127-90 | Hall Classic Blade | 16 |
| V190-137-05 | Hall Classic Blade | 16 |
| V190-137-90 | Hall Classic Blade | 16 |
| V190-147-05 | Hall Classic Blade | 16 |
| V190-147-90 | Hall Classic Blade | 16 |
| V193-119-90 | Hall Classic Blade | 16 |
| V193-127-90 | Hall Classic Blade | 16 |
| V193-137-90 | Hall Classic Blade | 16 |
| V250-089-90 | Hall Classic Blade | 16 |
| V250-100-90 | Hall Classic Blade | 16 |
| V250-107-90 | Hall Classic Blade | 16 |
| V250-119-90 | Hall Classic Blade | 16 |
| V250-127-90 | Hall Classic Blade | 54 |
| V250-137-90 | Hall Classic Blade | 55 |
| V250-147-90 | Hall Classic Blade | 55 |
| X10D | Micro Fine Round Diamond Bur | 54 |
| X40B | Micro Oval Bur | 55 |
| X55B | Micro Oval Bur | 55 |
| X60R | Micro Round Fluted Bur | 54 |

Alphabetical Index



| Cat. No. | Description | Page No. |
|-------------|---|------------|
| PR07001T | 1/2 Size Inner Tray, Drill Set | 13 |
| PR07002T | 1/2 Size Inner Tray, Saw Set | 6 |
| PR07003T | 1/2 Size Inner Tray, Small Bone Set | 40 |
| TR12R | 1/2 Size Rigid Sterilization Container | 16 |
| PR02041 | 1/4" (6.35mm) Jacobs Chuck | 13 |
| 5044-999-52 | 1/4" (6.35mm) Replacement Chuck Key | 13 |
| PR02250 | 1/4" Keyless Chuck | 8 |
| PR06050 | 1/8" Keyless Chuck | 10 |
| A201 | 10' (3.05m) Hose for Staplizer® Handpiece | 48 |
| 5020-053 | 2-Pedal Footswitch | 81 |
| PR06202M | 2-Trigger Modular Handpiece | 7 |
| 7020-024 | 20 degree Angle X-Long Keyless Attachment | 83, 84 |
| 1375-032 | 20 degree Angled Attachment | 43, 54, 56 |
| 7020-023 | 20 degree Long Keyless Attachment | 61, 83, 84 |
| 1375-033 | 20 degree X-Long Angled Attachment | 43, 56 |
| C9863 | 3-Pedal Footswitch | 68 |
| PR02042 | 3:1 1/4" High Torque Jacobs Chuck | 13 |
| PR02060 | 3:1 Aesculap Reamer | 13 |
| PR02080 | 3:1 DHS Reamer | 13 |
| PR02065 | 3:1 Hudson Reamer (DePuy) | 13 |
| PR02040 | 3:1 Large AO Reamer | 13 |
| PR02329 | 3:1 Trinkle Reamer | 8 |
| PR02047 | 3:1 Zimmer/Hudson Reamer | 13 |
| E9417 | 3.7mm FESS Irrigation Tubing Set for E9005 Shaver (Not Shown) | 55 |
| PR07000T | 3/4 Size Inner Tray, Full Set | 44 |
| TR34R | 3/4 Size Rigid Sterilization Container | 16 |
| E9416 | 4.2mm FESS Irrigation Tubing Set for E9005 Shaver | 54 |
| PR06042 | 5:1 1/4" High Torque Jacobs Chuck | 13 |
| PR06060 | 5:1 Aesculap Reamer | 12 |
| PR06048 | 5:1 Hudson Reamer(DePuy) | 10 |
| PR06040 | 5:1 Large AO Reamer | 13 |
| PR06047 | 5:1 Zimmer/Hudson Reamer | 13 |
| PR02030 | 5/32" (4.0mm) Jacobs Chuck, with Chuck Key | 13 |
| 5044-999-53 | 5/32" (4.0mm) Replacement Chuck Key | 13 |
| 1375-034 | 70 degree Contra Angle with Dental Head | 43 |
| 1375-035 | 70 degree Contra Angle with Surgical Head | 43, 54, 55 |
| 5056-080 | 80 Grit Dermabrasion Osteon Bur | 75 |
| 5056-081 | 80 Grit Dermabrasion Osteon Bur | 75 |
| 5056-082 | 80 Grit Dermabrasion Osteon Bur | 75 |
| 5056-083 | 80 Grit Dermabrasion Osteon Bur | 75 |
| 7020-022 | 90 degree Angle Attachment (like Midas AF/BF) | 61, 83, 84 |
| 1375-036 | 90 degree Angled Attachment | 43, 54, 55 |
| 5039-003 | AC Power Cord | 81 |
| 5071-105 | ACL Graft Harvesting, Large Bone Oscillating Blade | 31 |
| 5071-106 | ACL Graft Harvesting, Large Bone Oscillating Blade | 31 |
| 5071-107 | ACL Graft Harvesting, Large Bone Oscillating Blade | 31 |
| 5071-108 | ACL Graft Harvesting, Large Bone Oscillating Blade | 31 |
| 5071-109 | ACL Graft Harvesting, Large Bone Oscillating Blade | 31 |
| 5071-110 | ACL Graft Harvesting, Large Bone Oscillating Blade | 31 |
| 5071-111 | ACL Graft Harvesting, Large Bone Oscillating Blade | 31 |
| 5071-112 | ACL Graft Harvesting, Large Bone Oscillating Blade | 31 |
| 5071-113 | ACL Graft Harvesting, Large Bone Oscillating Blade | 31 |
| 5071-127 | ACL Large Bone Oscillating Blade | 32 |
| 5071-133 | ACL Large Bone Oscillating Blade | 32 |
| 5071-134 | ACL Large Bone Oscillating Blade | 32 |

| Cat. No. | Description | Page No. |
|----------|---|----------------|
| 5071-135 | ACL Large Bone Oscillating Blade | 33 |
| 5071-236 | ACL Large Bone Oscillating Blade | 32 |
| 5071-246 | ACL Large Bone Oscillating Blade | 32 |
| 5071-571 | ACL Large Bone Oscillating Blade | 33 |
| D3000 | Advantage Console | 73 |
| PR02029 | AO/Trinkle | 13 |
| 7020-041 | Attachment Spray | 61, 83, 84 |
| PRO3110 | Battery Case for PRO3115 | 9 |
| PRO3521 | Battery Case for PRO3520 | 8 |
| M105A | Blitz Instrument Cleaner (Use with Staplizer Handpiece) | 55 |
| 7020-046 | Bur Cabinet for Neuro Burs | 64, 66, 84 |
| 1375-003 | Bur Changer for 70 and 90 degree Angled Attachments | 43 |
| 1375-015 | Bur Cleaning Brush | 79, 83, 85, 86 |
| 5038-009 | Bur Rack, for Osteon and Ototom Burs | 74, 85, 86 |
| E9323 | Bur Rack, Holds up to 20 burs for E9010 Drill | 69 |
| 1375-112 | Burguard Sleeve Surgairtome Two | 42 |
| 5050-041 | C-Wire | 78 |
| 5050-042 | C-Wire | 78 |
| 5050-043 | C-Wire | 78 |
| 5050-044 | C-Wire | 78 |
| 5050-046 | C-Wire | 78 |
| 5050-047 | C-Wire | 78 |
| 5050-048 | C-Wire | 78 |
| 5050-049 | C-Wire | 78 |
| 5052-181 | Cebotome Bur | 77 |
| 5052-182 | Cebotome Bur | 77 |
| 5052-183 | Cebotome Bur | 77 |
| 5052-184 | Cebotome Bur | 77 |
| 5052-185 | Cebotome Bur | 77 |
| 5052-186 | Cebotome Bur | 77 |
| 5052-187 | Cebotome Bur | 77 |
| 5052-188 | Cebotome Bur | 77 |
| 5052-189 | Cebotome Bur | 77 |
| 5052-190 | Cebotome Bur | 77 |
| 5052-191 | Cebotome Bur | 77 |
| 5052-192 | Cebotome Bur | 77 |
| 5052-046 | Cebotome Bur Wrench | 76, 86 |
| 5052-144 | Cebotome Diamond Metal Cutting Bur | 77, 86 |
| 5052-145 | Cebotome Diamond Metal Cutting Bur | 77, 86 |
| 5052-143 | Cebotome Metal Cutting Bur Wrench | 76, 86 |
| 5052-129 | Cebotome Metal Cutting Wheel Wrench | 86 |
| 5052-125 | Cebotome Metal Cutting Wheels | 77, 86 |
| 5052-126 | Cebotome Metal Cutting Wheels | 77, 86 |
| 5052-041 | Cebotome Revision Drill Handpiece | 76, 86 |
| PR03135 | Charging Platform for PR03115 | 9 |
| PR03535 | Charging Platform for PR03520 | 13 |
| 5053-124 | Cleaning Brush for Cannulated Handpieces | 79 |
| 5056-950 | Coarse Diamond Round Osteon Bur | 75 |
| 5056-952 | Coarse Diamond Round Osteon Bur | 75 |
| 5056-958 | Coarse Diamond Round Osteon Bur | 75 |
| 5056-959 | Coarse Diamond Round Osteon Bur | 75 |
| 5056-962 | Coarse Diamond Round Osteon Bur | 75 |
| 5056-967 | Coarse Diamond Round Osteon Bur | 75 |
| E5050 | Coarse Round Diamond E Bur | 72 |
| E5120 | Coarse Round Diamond E Bur | 72 |

Alphabetical Index



| Cat. No. | Description | Page No. |
|----------|--|----------|
| E5130 | Coarse Round Diamond E Bur | 72 |
| E5140 | Coarse Round Diamond E Bur | 72 |
| E5150 | Coarse Round Diamond E Bur | 72 |
| E5160 | Coarse Round Diamond E Bur | 72 |
| E5170 | Coarse Round Diamond E Bur | 72 |
| E5210 | Coarse Round Diamond E Bur | 72 |
| E5215 | Coarse Round Diamond E Bur | 72 |
| E5220 | Coarse Round Diamond E Bur | 72 |
| E5225 | Coarse Round Diamond E Bur | 72 |
| E5230 | Coarse Round Diamond E Bur | 72 |
| E5240 | Coarse Round Diamond E Bur | 72 |
| 5020-054 | Console Stand | 81 |
| E9010 | CoolFlex High Speed Drill | 73 |
| E9015 | Cranial Perforator Drive | 68 |
| N9375 | Curved Vortex Router 4.5mm, 45° Pre-Bent, 11.5cm Working Length, 6/Box | 71 |
| D4000 | D4000 Console | 73 |
| D4000A | D4000 Console with Irrigation | 73 |
| E9315 | DeClogger for removing tissue and bone from shaver blades and burs | 68 |
| 5056-170 | Deep Access Osteon Bur | 75 |
| 5056-171 | Deep Access Osteon Bur | 75 |
| 5056-172 | Deep Access Osteon Bur | 75 |
| 5056-175 | Deep Access Osteon Bur | 75 |
| 5056-176 | Deep Access Osteon Bur | 75 |
| M322 | DISS to Schrader Adapter | 55 |
| E9415A | Drill Tubing for E9010 Drill with irrigation tip | 43 |
| E9414 | Drill Tubing for E9010 Drill without irrigation tip | 67 |
| PR01541 | Drill-Ream Attachment, 1/4" (6.35mm) Chuck | 80 |
| PR01540 | Drill-Ream Attachment, AO | 13 |
| PR01548 | Drill-Ream Attachment, DePuy/Hudson | 13 |
| PR01547 | Drill-Ream Attachment, Zimmer/Hudson | 13 |
| E9000 | E9000 Console | 67 |
| E4217 | E9010 Lindemann Bur | 72 |
| E4208 | E9010 Side Cutting Bur | 72 |
| E4220 | E9010 Side Cutting Bur | 72 |
| 5052-029 | Extension Hose, 10' (3.05m), Male Diss and Female Schrader | 82 |
| 5052-018 | Extension Hose, 10' (3.05m), Male Schrader to Female Schrader | 82 |
| 5056-147 | Fine Diamond Round Osteon Bur | 75 |
| 5056-148 | Fine Diamond Round Osteon Bur | 75 |
| 5056-150 | Fine Diamond Round Osteon Bur | 75 |
| 5056-152 | Fine Diamond Round Osteon Bur | 75, 85 |
| 5056-158 | Fine Diamond Round Osteon Bur | 75, 85 |
| 5056-159 | Fine Diamond Round Osteon Bur | 75, 85 |
| 5056-160 | Fine Diamond Round Osteon Bur | 75 |
| 5056-161 | Fine Diamond Round Osteon Bur | 75, 85 |
| 5056-162 | Fine Diamond Round Osteon Bur | 75, 85 |
| 5056-163 | Fine Diamond Round Osteon Bur | 75 |
| 5056-167 | Fine Diamond Round Osteon Bur | 75 |
| 5056-168 | Fine Diamond Round Osteon Bur | 75 |
| E6040 | Fine Round Diamond E Bur | 72 |
| E6105 | Fine Round Diamond E Bur | 72 |
| E6110 | Fine Round Diamond E Bur | 72 |
| E6115 | Fine Round Diamond E Bur | 72 |
| E6120 | Fine Round Diamond E Bur | 72 |
| E6125 | Fine Round Diamond E Bur | 72 |
| E6130 | Fine Round Diamond E Bur | 72 |

| Cat. No. | Description | Page No. |
|-----------------|---|-----------------|
| E6140 | Fine Round Diamond E Bur | 72 |
| E6150 | Fine Round Diamond E Bur | 72 |
| E6160 | Fine Round Diamond E Bur | 72 |
| E6205 | Fine Round Diamond E Bur | 72 |
| E6207 | Fine Round Diamond E Bur | 72 |
| E6210 | Fine Round Diamond E Bur | 72 |
| E6215 | Fine Round Diamond E Bur | 72 |
| E6220 | Fine Round Diamond E Bur | 72 |
| E6225 | Fine Round Diamond E Bur | 72 |
| E6230 | Fine Round Diamond E Bur | 72 |
| E6240 | Fine Round Diamond E Bur | 72 |
| E6250 | Fine Round Diamond E Bur | 72 |
| 5040-180 | Fluid Bag Support Rod for D3000 & E9000 | 81 |
| 5056-116 | Fluted Round Osteon Bur | 75 |
| 5056-117 | Fluted Round Osteon Bur | 75, 85 |
| 5056-118 | Fluted Round Osteon Bur | 75, 85 |
| 5056-119 | Fluted Round Osteon Bur | 75, 85 |
| 5056-125 | Fluted Round Osteon Bur | 75 |
| 5056-126 | Fluted Round Osteon Bur | 75, 85 |
| 5056-127 | Fluted Round Osteon Bur | 75 |
| 5056-128 | Fluted Round Osteon Bur | 75 |
| 5056-140 | Fluted Round Osteon Bur | 75, 85 |
| 5056-142 | Fluted Round Osteon Bur | 75, 85 |
| 5056-144 | Fluted Round Osteon Bur | 75 |
| 5056-145 | Fluted Round Osteon Bur | 75, 85 |
| 5056-146 | Fluted Round Osteon Bur | 75, 85 |
| 5056-149 | Fluted Round Osteon Bur | 75 |
| 5056-164 | Fluted Round Osteon Bur | 75, 85 |
| 5056-165 | Fluted Round Osteon Bur | 75 |
| 5056-166 | Fluted Round Osteon Bur | 75, 85 |
| 5056-173 | Fluted Round Osteon Bur | 75 |
| 5056-174 | Fluted Round Osteon Bur | 75 |
| 5056-177 | Fluted Round Osteon Bur | 75 |
| 5056-178 | Fluted Round Osteon Bur | 75 |
| 5056-179 | Fluted Round Osteon Bur | 75 |
| PRO7100B | Hall 50 1-Trigger Modular Handpiece | 40 |
| PRO7200B | Hall 50 2-Trigger Modular Handpiece | 40 |
| PRO7300B | Hall 50 Oscillating Saw Handpiece | 40 |
| PRO7400B | Hall 50 Reciprocating Saw Handpiece | 18 |
| PRO7450B | Hall 50 Sternum Saw Handpiece | 18 |
| V130-089-90 | Hall Classic Blade | 16 |
| V130-100-90 | Hall Classic Blade | 16 |
| V130-107-90 | Hall Classic Blade | 16 |
| V130-119-90 | Hall Classic Blade | 16 |
| V130-127-90 | Hall Classic Blade | 16 |
| V130-137-90 | Hall Classic Blade | 16 |
| V130-147-90 | Hall Classic Blade | 16 |
| V190-089-05 | Hall Classic Blade | 16 |
| V190-089-90 | Hall Classic Blade | 16 |
| V190-100-05 | Hall Classic Blade | 16 |
| V190-100-90 | Hall Classic Blade | 16 |
| V190-107-05 | Hall Classic Blade | 16 |
| V190-107-90 | Hall Classic Blade | 16 |
| V190-119-05 | Hall Classic Blade | 16 |
| V190-119-90 | Hall Classic Blade | 16 |

Alphabetical Index



| Cat. No. | Description | Page No. |
|-----------------|----------------------------|-----------------|
| V190-127-05 | Hall Classic Blade | 16 |
| V190-127-90 | Hall Classic Blade | 16 |
| V190-137-05 | Hall Classic Blade | 16 |
| V190-137-90 | Hall Classic Blade | 16 |
| V190-147-05 | Hall Classic Blade | 16 |
| V190-147-90 | Hall Classic Blade | 16 |
| V193-119-90 | Hall Classic Blade | 16 |
| V193-127-90 | Hall Classic Blade | 16 |
| V193-137-90 | Hall Classic Blade | 16 |
| V250-089-90 | Hall Classic Blade | 16 |
| V250-100-90 | Hall Classic Blade | 16 |
| V250-107-90 | Hall Classic Blade | 16 |
| V250-119-90 | Hall Classic Blade | 16 |
| V250-127-90 | Hall Classic Blade | 54 |
| V250-137-90 | Hall Classic Blade | 55 |
| V250-147-90 | Hall Classic Blade | 55 |
| 5071-120 | Hall Large Bone Knee Blade | 20 |
| 5071-121 | Hall Large Bone Knee Blade | 21 |
| 5071-123 | Hall Large Bone Knee Blade | 24 |
| 5071-124 | Hall Large Bone Knee Blade | 25 |
| 5071-129 | Hall Large Bone Knee Blade | 25 |
| 5071-144 | Hall Large Bone Knee Blade | 26 |
| 5071-146 | Hall Large Bone Knee Blade | 20 |
| 5071-161 | Hall Large Bone Knee Blade | 24 |
| 5071-163 | Hall Large Bone Knee Blade | 26 |
| 5071-167 | Hall Large Bone Knee Blade | 21 |
| 5071-180 | Hall Large Bone Knee Blade | 23 |
| 5071-181 | Hall Large Bone Knee Blade | 23 |
| 5071-184 | Hall Large Bone Knee Blade | 21 |
| 5071-185 | Hall Large Bone Knee Blade | 20 |
| 5071-195 | Hall Large Bone Knee Blade | 20 |
| 5071-196 | Hall Large Bone Knee Blade | 20 |
| 5071-201 | Hall Large Bone Knee Blade | 23 |
| 5071-519 | Hall Large Bone Knee Blade | 25 |
| 5071-525 | Hall Large Bone Knee Blade | 26 |
| 5071-526 | Hall Large Bone Knee Blade | 22 |
| 5071-527 | Hall Large Bone Knee Blade | 23 |
| 5071-528 | Hall Large Bone Knee Blade | 19 |
| 5071-529 | Hall Large Bone Knee Blade | 25 |
| 5071-530 | Hall Large Bone Knee Blade | 26 |
| 5071-531 | Hall Large Bone Knee Blade | 23 |
| 5071-532 | Hall Large Bone Knee Blade | 20 |
| 5071-533 | Hall Large Bone Knee Blade | 19 |
| 5071-534 | Hall Large Bone Knee Blade | 22 |
| 5071-538 | Hall Large Bone Knee Blade | 21 |
| 5071-539 | Hall Large Bone Knee Blade | 26 |
| 5071-547 | Hall Large Bone Knee Blade | 21 |
| 5071-548 | Hall Large Bone Knee Blade | 21 |
| 5071-558 | Hall Large Bone Knee Blade | 22 |
| 5071-562 | Hall Large Bone Knee Blade | 21 |
| 5071-564 | Hall Large Bone Knee Blade | 24 |
| 5071-565 | Hall Large Bone Knee Blade | 26 |
| 5071-568 | Hall Large Bone Knee Blade | 24 |
| 5071-570-50 | Hall Large Bone Knee Blade | 22 |
| 5071-573 | Hall Large Bone Knee Blade | 22 |

| Cat. No. | Description | Page No. |
|-----------------|---|-----------------|
| 5071-575 | Hall Large Bone Knee Blade | 22 |
| 5071-576 | Hall Large Bone Knee Blade | 24 |
| 5071-582 | Hall Large Bone Knee Blade | 23 |
| 5071-583 | Hall Large Bone Knee Blade | 19 |
| 5071-589 | Hall Large Bone Knee Blade | 20 |
| 5071-590 | Hall Large Bone Knee Blade | 24 |
| 5071-594 | Hall Large Bone Knee Blade | 19 |
| 5071-650 | Hall Large Bone Knee Blade | 19 |
| 5271-502 | Hall Large Bone Knee Blade | 19 |
| 5271-561 | Hall Large Bone Knee Blade | 24 |
| 5271-580 | Hall Large Bone Knee Blade | 23 |
| 5052-173 | Hall Large Bone Reciprocating Blade | 38 |
| 5052-179 | Hall Large Bone Reciprocating Blade | 38 |
| 5052-258 | Hall Large Bone Reciprocating Blade | 38 |
| 5052-259 | Hall Large Bone Reciprocating Blade | 38 |
| 5052-260 | Hall Large Bone Reciprocating Blade | 38 |
| 5052-261 | Hall Large Bone Reciprocating Blade | 38 |
| 5052-276 | Hall Large Bone Reciprocating Blade | 38 |
| 5052-281 | Hall Large Bone Reciprocating Blade | 38 |
| 5052-291 | Hall Large Bone Reciprocating Blade | 38 |
| L3000LG | Hall Large Lithium Battery, 13.2 Volt | 56 |
| 1365-016 | Hall Lubricant for Angled Attachments | 82 |
| 1375-037 | Hall Lubricant for Surgical Angled Attachments | 82 |
| L300SM | Hall Small Lithium Battery, 13.2 Volt | 55 |
| L3000 | Hall® Lithium Charger | 55 |
| MC5057 | Handpiece Cord | 69 |
| N9320 | Head & Neck Blade 3.5mm, 7.0cm Working Length, 6/Box | 70 |
| N9321 | Head & Neck Blade 4.2mm, 11.5cm Working Length, 6/Box | 71 |
| 7021-960 | Helical Bur for E9010 Drill | 78 |
| PRO2033 | High Speed Drill Attachment | 13 |
| E9005 | High Speed Shaver | 73 |
| M317 | Instrument Lubricant for Staplizer | 56 |
| 5071-300 | Intrex Blade | 17 |
| 5071-301 | Intrex Blade | 17 |
| 5071-302 | Intrex Blade | 17 |
| 5071-303 | Intrex Blade | 17 |
| 5071-304 | Intrex Blade | 17 |
| 5071-305 | Intrex Blade | 17 |
| 5071-306 | Intrex Blade | 17 |
| 5071-310 | Intrex Blade | 17 |
| 5071-311 | Intrex Blade | 17 |
| 5071-312 | Intrex Blade | 17 |
| 5071-313 | Intrex Blade | 17 |
| 5071-314 | Intrex Blade | 17 |
| 5071-315 | Intrex Blade | 17 |
| 5071-316 | Intrex Blade | 17 |
| 5071-320 | Intrex Blade | 17 |
| 5071-321 | Intrex Blade | 17 |
| 5071-322 | Intrex Blade | 17 |
| 5071-323 | Intrex Blade | 17 |
| 5071-324 | Intrex Blade | 17 |
| 5071-325 | Intrex Blade | 17 |
| 5071-326 | Intrex Blade | 17 |
| 5071-330 | Intrex Blade | 17 |
| 5071-331 | Intrex Blade | 17 |

Alphabetical Index



| Cat. No. | Description | Page No. |
|----------|--|---------------------|
| 5071-332 | Intrex Blade | 17 |
| 5071-333 | Intrex Blade | 17 |
| 5071-334 | Intrex Blade | 17 |
| 5071-335 | Intrex Blade | 17 |
| 5071-336 | Intrex Blade | 17 |
| 5071-340 | Intrex Blade | 17 |
| 5071-341 | Intrex Blade | 17 |
| 5071-342 | Intrex Blade | 17 |
| 5071-343 | Intrex Blade | 17 |
| 5071-344 | Intrex Blade | 17 |
| 5071-345 | Intrex Blade | 17 |
| 5071-346 | Intrex Blade | 17 |
| 5071-350 | Intrex Blade | 17 |
| 5071-351 | Intrex Blade | 17 |
| 5071-352 | Intrex Blade | 17 |
| 5071-353 | Intrex Blade | 17 |
| 5071-354 | Intrex Blade | 17 |
| 5071-355 | Intrex Blade | 17 |
| 5071-356 | Intrex Blade | 17 |
| E9418 | Irrigation Tubing Set | 55 |
| 7020-040 | Key Wrench, 2 per box | 83, 84 |
| 1375-020 | Laminectomy Guard | 43, 55 |
| PR02070 | Large AO | 13 |
| 5071-175 | Large Bone Oscillating Abrader | 37 |
| 5071-132 | Large Bone Oscillating Blade | 34 |
| 5071-140 | Large Bone Oscillating Blade | 37 |
| 5071-141 | Large Bone Oscillating Blade | 36 |
| 5071-142 | Large Bone Oscillating Blade | 37 |
| 5071-143 | Large Bone Oscillating Blade | 36 |
| 5071-145 | Large Bone Oscillating Blade | 37 |
| 5071-166 | Large Bone Oscillating Blade | 34 |
| 5071-174 | Large Bone Oscillating Blade | 36 |
| 5071-177 | Large Bone Oscillating Blade | 35 |
| 5071-178 | Large Bone Oscillating Blade | 35 |
| 5071-186 | Large Bone Oscillating Blade | 35 |
| 5071-187 | Large Bone Oscillating Blade | 35 |
| 5071-188 | Large Bone Oscillating Blade | 35 |
| 5071-550 | Large Bone Oscillating Blade | 34 |
| 5071-551 | Large Bone Oscillating Blade | 34 |
| 5071-552 | Large Bone Oscillating Blade | 34 |
| 5071-553 | Large Bone Oscillating Blade | 34 |
| 5071-554 | Large Bone Oscillating Blade | 36 |
| 5071-555 | Large Bone Oscillating Blade | 37 |
| 5071-556 | Large Bone Oscillating Blade | 35 |
| 5071-557 | Large Bone Oscillating Blade | 36 |
| 5071-560 | Large Bone Oscillating Blade | 36 |
| 5071-572 | Large Bone Oscillating Blade | 35 |
| PR03010 | Large NiCad Battery, 9.6 Volt | 9 |
| PR03115 | Large NiMH Sterile Transfer Battery, 9.6 Volt | 9 |
| E9363 | Laryngeal Blade 3.7mm, Bendable to 45°, 20.0cm Working Length, 6/Box | 67 |
| E9012 | Locking Collar for E9010 Drill | 67 |
| 1375-011 | Long Bur Guard | 43, 54 - 56 |
| 7020-019 | Long Bur Guard (like Midas S-1) Brown | 61, 73, 83, 84 |
| 7020-012 | Long Bur Guard (like Midas-M/B) Mustard | 61 - 66, 73, 83, 84 |
| E9011-2 | Long Bur Guard for E9010 Drill | 67, 72, 73 |

| Cat. No. | Description | Page No. |
|-----------------|---|---------------------|
| E9011-9 | Long Neuro Guard for E9010 Drill | 67 |
| 1375-011P | Long Precision Bur Guard | 43 |
| 7020-016 | Long Revision Extension (like Midas RX) Blue | 61, 62, 65, 83, 84 |
| E8030LSO | LSO Round Fluted E Bur | 72 |
| E8040LSO | LSO Round Fluted E Bur | 72 |
| E8050LSO | LSO Round Fluted E Bur | 72 |
| E8065LSO | LSO Round Fluted E Bur | 72 |
| E8130LSO | LSO Round Fluted E Bur | 72 |
| E8140LSO | LSO Round Fluted E Bur | 72 |
| E8150LSO | LSO Round Fluted E Bur | 72 |
| E8165LSO | LSO Round Fluted E Bur | 72 |
| E8230LSO | LSO Round Fluted E Bur | 80 |
| E8240LSO | LSO Round Fluted E Bur | 67 |
| E8265LSO | LSO Round Fluted E Bur | 67 |
| N9150 | Lynx Blade 4.2mm, Irrigated, 10.5cm Working Length, 6/Box | 69 |
| TN130-089-90 | M-Class Blade | 15 |
| TN130-100-90 | M-Class Blade | 15 |
| TN130-107-90 | M-Class Blade | 15 |
| TN130-119-90 | M-Class Blade | 15 |
| TN130-127-90 | M-Class Blade | 15 |
| TN130-137-90 | M-Class Blade | 15 |
| TN130-147-90 | M-Class Blade | 15 |
| TN190-089-90 | M-Class Blade | 15 |
| TN190-100-90 | M-Class Blade | 15 |
| TN190-107-90 | M-Class Blade | 15 |
| TN190-119-05 | M-Class Blade | 15 |
| TN190-119-90 | M-Class Blade | 15 |
| TN190-127-05 | M-Class Blade | 15 |
| TN190-127-90 | M-Class Blade | 15 |
| TN190-137-05 | M-Class Blade | 15 |
| TN190-137-90 | M-Class Blade | 15 |
| TN190-147-90 | M-Class Blade | 15 |
| TN193-119-90 | M-Class Blade | 15 |
| TN193-127-90 | M-Class Blade | 15 |
| TN193-137-90 | M-Class Blade | 15 |
| TN250-089-90 | M-Class Blade | 15 |
| TN250-100-90 | M-Class Blade | 15 |
| TN250-107-90 | M-Class Blade | 15 |
| TN250-119-90 | M-Class Blade | 15 |
| TN250-127-90 | M-Class Blade | 14 |
| TN250-137-90 | M-Class Blade | 44 |
| TN250-147-90 | M-Class Blade | 14 |
| 1375-012 | Medium Bur Guard | 43, 54 - 56, 83 |
| 7020-018 | Medium Bur Guard (like Midas B-1) Green | 61, 67, 83, 84 |
| 7020-011 | Medium Bur Guard (like Midas-O) Copper | 61 - 66, 83, 84 |
| E9011-1 | Medium Bur Guard for E9010 Drill | 67, 72, 73 |
| 5030-029 | Medium Holding Clamps | 79 |
| E9011-8 | Medium Neuro Guard for E9010 Drill | 67 |
| 1375-012P | Medium Precision Bur Guard | 43 |
| 7020-015 | Medium Revision Extension (like Midas-R) Purple | 61 - 63, 65, 83, 84 |
| 5052-142 | Metal Cutting Bur Extension | 76, 86 |
| 1375-028 | Micro 100 Footswitch | 82 |
| 5053-009 | Micro 100 Medium Speed Drill | 42 |
| 5053-012 | Micro 100 Oscillating Saw | 42 |
| 5053-010 | Micro 100 Reciprocating Saw | 42 |

Alphabetical Index



| Cat. No. | Description | Page No. |
|-----------------|--|-----------------|
| 5053-011 | Micro 100 Sagittal Saw | 42 |
| 5053-074 | Micro 100 Throttle Clip (for lever) Used during footswitch operation | 42 |
| 5053-013 | Micro 100 Wire Driver | 42 |
| 5053-022 | Micro 100 XL Oscillating Saw | 42 |
| 5023-182 | Micro ACL Sagittal Saw Blade | 48 |
| 5023-183 | Micro ACL Sagittal Saw Blade | 48 |
| 5023-184 | Micro ACL Sagittal Saw Blade | 48 |
| 5023-185 | Micro ACL Sagittal Saw Blade | 48 |
| 5023-186 | Micro ACL Sagittal Saw Blade | 48 |
| C8803 | Micro ACL Sagittal Saw Blade | 81 |
| C8804 | Micro ACL Sagittal Saw Blade | 71 |
| C8806 | Micro ACL Sagittal Saw Blade | 71 |
| 5023-167 | Micro Angled Oscillating Saw Blade | 50 |
| 5023-168 | Micro Angled Oscillating Saw Blade | 50 |
| 5023-258 | Micro Angled Oscillating Saw Blade | 50 |
| 5023-259 | Micro Angled Oscillating Saw Blade | 50 |
| 5023-128 | Micro Angled Sagittal Saw Blade | 47 |
| 5023-129 | Micro Angled Sagittal Saw Blade | 47 |
| 5023-134 | Micro Angled Sagittal Saw Blade | 47 |
| 5023-135 | Micro Angled Sagittal Saw Blade | 47 |
| 5023-136 | Micro Angled Sagittal Saw Blade | 47 |
| 5091-252 | Micro Barrel Bur | 55 |
| 5091-254 | Micro Barrel Bur | 55 |
| 5092-252 | Micro Barrel Bur | 55 |
| 5092-254 | Micro Barrel Bur | 55 |
| L45C | Micro Cone Bur | 82 |
| M45C | Micro Cone Bur | 54 |
| 5023-170 | Micro Crescentic Oscillating Saw Blade | 52 |
| 5023-171 | Micro Crescentic Oscillating Saw Blade | 52 |
| 5023-172 | Micro Crescentic Oscillating Saw Blade | 52 |
| 5023-176 | Micro Crescentic Oscillating Saw Blade | 52 |
| 5092-291 | Micro Cylindrical Bur | 56 |
| 5053-050 | Micro Depth Limiting Reciprocating Saw Blade | 53 |
| 5053-051 | Micro Depth Limiting Reciprocating Saw Blade | 53 |
| 5053-052 | Micro Depth Limiting Reciprocating Saw Blade | 53 |
| 5053-053 | Micro Depth Limiting Reciprocating Saw Blade | 53 |
| 5023-055 | Micro Dermabrader Sagittal Saw Blade | 49 |
| 5023-056 | Micro Dermabrader Sagittal Saw Blade | 49 |
| 5023-057 | Micro Dermabrader Sagittal Saw Blade | 49 |
| 5091-080 | Micro Dermabraders – Fine Diamond Bur | 54 |
| 5091-081 | Micro Dermabraders – Fine Diamond Bur | 54 |
| 5091-082 | Micro Dermabraders – Fine Diamond Bur | 54 |
| 5091-083 | Micro Dermabraders – Fine Diamond Bur | 54 |
| 5091-270 | Micro Dermabraders – Fine Diamond Bur | 54 |
| 5092-270 | Micro Dermabraders – Fine Diamond Bur | 54 |
| 5091-260 | Micro Fine Round Diamond Bur | 54 |
| 5091-264 | Micro Fine Round Diamond Bur | 54 |
| 5091-268 | Micro Fine Round Diamond Bur | 54 |
| 5092-260 | Micro Fine Round Diamond Bur | 54 |
| 5092-262 | Micro Fine Round Diamond Bur | 54 |
| 5092-264 | Micro Fine Round Diamond Bur | 54 |
| 5092-266 | Micro Fine Round Diamond Bur | 54 |
| 5092-268 | Micro Fine Round Diamond Bur | 54 |
| 5093-260 | Micro Fine Round Diamond Bur | 54 |
| 5093-262 | Micro Fine Round Diamond Bur | 54 |

| Cat. No. | Description | Page No. |
|-----------------|---|-----------------|
| 5093-264 | Micro Fine Round Diamond Bur | 54 |
| 5093-266 | Micro Fine Round Diamond Bur | 54 |
| L10D | Micro Fine Round Diamond Bur | 55 |
| M60D | Micro Fine Round Diamond Bur | 68 |
| X10D | Micro Fine Round Diamond Bur | 54 |
| 5023-405 | Micro Graft Harvesting Sagittal Saw Blade | 49 |
| 5023-406 | Micro Graft Harvesting Sagittal Saw Blade | 49 |
| 5023-407 | Micro Graft Harvesting Sagittal Saw Blade | 49 |
| 5023-408 | Micro Graft Harvesting Sagittal Saw Blade | 49 |
| 5023-409 | Micro Graft Harvesting Sagittal Saw Blade | 49 |
| 5023-410 | Micro Graft Harvesting Sagittal Saw Blade | 49 |
| 5023-411 | Micro Graft Harvesting Sagittal Saw Blade | 49 |
| 5023-412 | Micro Graft Harvesting Sagittal Saw Blade | 49 |
| 5023-413 | Micro Graft Harvesting Sagittal Saw Blade | 49 |
| 5092-283 | Micro Heavy Grit Diamond-Microbur. X-Long Bur | 56 |
| 5092-284 | Micro Heavy Grit Diamond-Microbur. X-Long Bur | 56 |
| 5092-285 | Micro Heavy Grit Diamond-Microbur. X-Long Bur | 56 |
| 5092-286 | Micro Heavy Grit Diamond-Microbur. X-Long Bur | 56 |
| 5093-282 | Micro Heavy Grit Diamond-Microbur. X-Long Bur | 56 |
| 5093-283 | Micro Heavy Grit Diamond-Microbur. X-Long Bur | 56 |
| 5093-284 | Micro Heavy Grit Diamond-Microbur. X-Long Bur | 56 |
| 5093-285 | Micro Heavy Grit Diamond-Microbur. X-Long Bur | 56 |
| 5023-101 | Micro Intra-Oral Oscillating Saw Blade | 51 |
| 5023-102 | Micro Intra-Oral Oscillating Saw Blade | 51 |
| 5023-103 | Micro Intra-Oral Oscillating Saw Blade | 51 |
| 5023-104 | Micro Intra-Oral Oscillating Saw Blade | 51 |
| 5091-212 | Micro Lindemann Bur | 56 |
| 5023-160 | Micro Oscillating Saw Blade | 50 |
| 5023-161 | Micro Oscillating Saw Blade | 50 |
| 5023-162 | Micro Oscillating Saw Blade | 50 |
| 5023-163 | Micro Oscillating Saw Blade | 50 |
| 5023-164 | Micro Oscillating Saw Blade | 50 |
| 5023-165 | Micro Oscillating Saw Blade | 50 |
| 5023-166 | Micro Oscillating Saw Blade | 50 |
| 5023-169 | Micro Oscillating Saw Blade | 50 |
| 5091-236 | Micro Oval Bur | 55 |
| 5091-238 | Micro Oval Bur | 55 |
| 5092-238 | Micro Oval Bur | 55 |
| 5093-236 | Micro Oval Bur | 55 |
| 5093-238 | Micro Oval Bur | 55 |
| L40B | Micro Oval Bur | 54 |
| L55B | Micro Oval Bur | 55 |
| M40B | Micro Oval Bur | 54 |
| M55B | Micro Oval Bur | 81 |
| X40B | Micro Oval Bur | 55 |
| X55B | Micro Oval Bur | 55 |
| 5053-080 | Micro Reciprocating Rasp | 53 |
| 5053-081 | Micro Reciprocating Rasp | 53 |
| 5053-082 | Micro Reciprocating Rasp | 53 |
| 5053-083 | Micro Reciprocating Rasp | 53 |
| 5053-084 | Micro Reciprocating Rasp | 53 |
| 5053-085 | Micro Reciprocating Rasp | 53 |
| 5053-054 | Micro Reciprocating Saw Blade | 53 |
| 5053-122 | Micro Reciprocating Saw Blade | 53 |
| 5053-126 | Micro Reciprocating Saw Blade | 53 |

Alphabetical Index



| Cat. No. | Description | Page No. |
|-----------------|-----------------------------------|-----------------|
| 5053-220 | Micro Reciprocating Saw Blade | 53 |
| 5053-221 | Micro Reciprocating Saw Blade | 53 |
| 5091-221 | Micro Round Fluted Bur | 54 |
| 5091-222 | Micro Round Fluted Bur | 54 |
| 5091-223 | Micro Round Fluted Bur | 54 |
| 5091-224 | Micro Round Fluted Bur | 54 |
| 5091-225 | Micro Round Fluted Bur | 54 |
| 5091-226 | Micro Round Fluted Bur | 54 |
| 5091-228 | Micro Round Fluted Bur | 54 |
| 5091-230 | Micro Round Fluted Bur | 54 |
| 5091-232 | Micro Round Fluted Bur | 54 |
| 5092-220 | Micro Round Fluted Bur | 54 |
| 5092-222 | Micro Round Fluted Bur | 54 |
| 5092-224 | Micro Round Fluted Bur | 54 |
| 5092-226 | Micro Round Fluted Bur | 54 |
| 5092-228 | Micro Round Fluted Bur | 54 |
| 5092-230 | Micro Round Fluted Bur | 54 |
| 5092-232 | Micro Round Fluted Bur | 54 |
| 5092-236 | Micro Round Fluted Bur | 54, 55 |
| 5093-220 | Micro Round Fluted Bur | 54 |
| 5093-221 | Micro Round Fluted Bur | 54 |
| 5093-224 | Micro Round Fluted Bur | 54 |
| 5093-226 | Micro Round Fluted Bur | 54 |
| 5093-228 | Micro Round Fluted Bur | 54 |
| 5093-230 | Micro Round Fluted Bur | 54 |
| 5093-232 | Micro Round Fluted Bur | 54 |
| L18R | Micro Round Fluted Bur | 8 |
| L23R | Micro Round Fluted Bur | 8 |
| L60R | Micro Round Fluted Bur | 55 |
| M60R | Micro Round Fluted Bur | 68 |
| X60R | Micro Round Fluted Bur | 54 |
| 5023-118 | Micro Sagittal Saw Blade | 45 |
| 5023-130 | Micro Sagittal Saw Blade | 45 |
| 5023-131 | Micro Sagittal Saw Blade | 45 |
| 5023-132 | Micro Sagittal Saw Blade | 45 |
| 5023-133 | Micro Sagittal Saw Blade | 45 |
| 5023-137 | Micro Sagittal Saw Blade | 45 |
| 5023-138 | Micro Sagittal Saw Blade | 45 |
| 5023-139 | Micro Sagittal Saw Blade | 45 |
| 5023-140 | Micro Sagittal Saw Blade | 45 |
| 5023-141 | Micro Sagittal Saw Blade | 46 |
| 5023-142 | Micro Sagittal Saw Blade | 46 |
| 5023-143 | Micro Sagittal Saw Blade | 46 |
| 5023-144 | Micro Sagittal Saw Blade | 45 |
| 5023-244 | Micro Sagittal Saw Blade | 46 |
| 5023-247 | Micro Sagittal Saw Blade | 46 |
| 5023-249 | Micro Sagittal Saw Blade | 46 |
| 5044-145 | Micro Sagittal Saw Blade | 46 |
| 5089-208 | Micro Straight Side – Cutting Bur | 55 |
| 5091-201 | Micro Straight Side – Cutting Bur | 55 |
| 5091-202 | Micro Straight Side – Cutting Bur | 55 |
| 5091-204 | Micro Straight Side – Cutting Bur | 55 |
| 5091-216 | Micro Straight Side – Cutting Bur | 55 |
| 5091-217 | Micro Straight Side – Cutting Bur | 55 |
| 5092-203 | Micro Straight Side – Cutting Bur | 55 |

| Cat. No. | Description | Page No. |
|-----------------|--|-----------------|
| 5092-204 | Micro Straight Side – Cutting Bur | 55 |
| L13S | Micro Straight Side – Cutting Bur | 55 |
| L17S | Micro Straight Side – Cutting Bur | 54 |
| M10S | Micro Straight Side – Cutting Bur | 55 |
| M13S | Micro Straight Side – Cutting Bur | 82 |
| M15S | Micro Straight Side – Cutting Bur | 82 |
| M17S | Micro Straight Side – Cutting Bur | 55 |
| 5091-242 | Micro Swanson Reamer Bur | 54 |
| 5091-243 | Micro Swanson Reamer Bur | 54 |
| 5091-244 | Micro Swanson Reamer Bur | 54 |
| 5091-245 | Micro Swanson Reamer Bur | 54 |
| 5091-213 | Micro Tapered Cross-cut Fissure Bur | 56 |
| 5091-271 | Micro Tapered Cross-cut Fissure Bur | 56 |
| 5091-272 | Micro Tapered Cross-cut Fissure Bur | 56 |
| 5092-271 | Micro Tapered Cross-cut Fissure Bur | 56 |
| 5092-272 | Micro Tapered Cross-cut Fissure Bur | 56 |
| 5092-273 | Micro Tapered Cross-cut Fissure Bur | 56 |
| 5091-206 | Micro Tapered Side – Cutting Bur | 55 |
| 5091-214 | Micro Tapered Side – Cutting Bur | 55 |
| 5091-215 | Micro Tapered Side – Cutting Bur | 55 |
| 5091-218 | Micro Tapered Side – Cutting Bur | 55 |
| 5091-219 | Micro Tapered Side – Cutting Bur | 55 |
| 5092-206 | Micro Tapered Side – Cutting Bur | 55 |
| 5092-214 | Micro Tapered Side – Cutting Bur | 55 |
| L12T | Micro Tapered Side – Cutting Bur | 54 |
| L20T | Micro Tapered Side – Cutting Bur | 8 |
| M12T | Micro Tapered Side – Cutting Bur | 55 |
| M20T | Micro Tapered Side – Cutting Bur | 55 |
| 5090-247 | Micro Wire Pass Bur | 54 |
| 5090-248 | Micro Wire Pass Bur | 54 |
| 5090-249 | Micro Wire Pass Bur | 54 |
| 5091-247 | Micro Wire Pass Bur | 54 |
| 5091-248 | Micro Wire Pass Bur | 54 |
| 5091-249 | Micro Wire Pass Bur | 54 |
| 5092-247 | Micro Wire Pass Bur | 54 |
| 6021-021 | MicroPower Medium Speed Drill, Permanently Attached Lever | 41 |
| 6020-021 | MicroPower Medium Speed Drill, Removable Lever | 41 |
| 6021-026 | MicroPower Orthopedic High Speed Drill, Permanently Attached Lever | 41 |
| 6020-026 | MicroPower Orthopedic High Speed Drill, Removable Lever | 41 |
| 6020-024 | MicroPower Oscillating Saw, Permanently Attached Lever | 41 |
| 6021-024 | MicroPower Oscillating Saw, Permanently Attached Lever | 41 |
| 6021-023 | MicroPower Reciprocating Saw, Permanently Attached Lever | 41 |
| 6020-023 | MicroPower Reciprocating Saw, Removable Lever | 41 |
| 6021-022 | MicroPower Sagittal Saw, Permanently Attached Lever | 41 |
| 6020-022 | MicroPower Sagittal Saw, Removable Lever | 41 |
| PRO7100SE | MicroPower+ Medium Speed Drill | 6 |
| PRO7000SE | MicroPower+ Orthopedic High Speed Drill | 14 |
| PRO7300SE | MicroPower+ Oscillating Saw | 57 |
| PRO7400SE | MicroPower+ Reciprocating Saw | 18 |
| PRO7200SE | MicroPower+ Sagittal Saw | 6 |
| N9330 | MicroXcisor Blade 4.2mm, Irrigated, 10.5cm Working Length, 6/Box | 71 |
| PRO2039 | Mini AO | 13 |
| PRO6450M | Mpower 2 Battery Sternum Saw | 14 |
| PRO7020 | Multipurpose High Speed | 6 |
| PRO3600 | NiCad Battery Charger | 13 |

Alphabetical Index



| Cat. No. | Description | Page No. |
|-----------|--|------------|
| PR07000DE | Oral Max Elite High Speed Drill | 14 |
| 6020-025 | Oral Max High Speed Drill, Removable Lever | 41 |
| 6021-025 | Oral Max™ High Speed Drill, Permanently Attached Lever | 41 |
| PR06125 | Oscillating Saw | 12 |
| PR06175 | Oscillating Saw | 7 |
| PR06350M | Oscillating Saw | 40 |
| 5038-004 | Osteon Footswitch with Hose | 74, 85, 86 |
| 5038-002 | Osteon Handpiece, Angled | 74, 85, 86 |
| 5038-001 | Osteon Handpiece, Straight | 74, 85, 86 |
| 5038-005 | Osteon Hose | 74, 85, 86 |
| 5038-600 | Osteon Tubing Set with irrigation tip | 74 |
| 5056-109 | Osteon/Ototome Bur Set, includes 16 burs (see System Listings Page 26) | 74 |
| N9390 | Otolaryngology Bur 4.0mm, Hooded, 10.8cm Working Length, 6/Box | 13 |
| PR06240 | Pin Driver Range: 1.8 – 4.0mm (0.071 – 0.157") | 57 |
| PR06140 | Pin Driver, Range: 1.8 – 4.0mm (0.071 – 0.157") | 11 |
| 5059-005 | Pneumatic Sternum Saw | 57 |
| PR02000 | PowerPro Console | 13 |
| PR02514 | Radiolucent Drive Adaptor | 8 |
| PR06135 | Reciprocating Saw | 11 |
| PR06185 | Reciprocating Saw | 12 |
| PR06400M | Reciprocating Saw | 40 |
| PR06045 | Reciprocating Saw Attachment for PR06100, PR06150, PR06200M, & PR06202M | 13 |
| M208 | Regulator, Dual Connection | 82 |
| M207 | Regulator, Single Connection | 82 |
| 1384-175 | Repeat Sternotomy Blade | 58 |
| 1384-176 | Repeat Sternotomy Blade | 58 |
| 5023-178 | Repeat Sternotomy Blade | 59 |
| 5023-179 | Repeat Sternotomy Blade | 59 |
| 5023-180 | Repeat Sternotomy Blade | 59 |
| 5023-187 | Repeat Sternotomy Blade | 58 |
| 5023-188 | Repeat Sternotomy Blade | 58 |
| 5059-278 | Repeat Sternotomy Blade | 59 |
| 5059-279 | Repeat Sternotomy Blade | 59 |
| 5059-280 | Repeat Sternotomy Blade | 59 |
| 5071-125 | Repeat Sternotomy Blade | 60 |
| 5071-126 | Repeat Sternotomy Blade | 60 |
| 5071-228 | Repeat Sternotomy Blade | 60 |
| 5071-229 | Repeat Sternotomy Blade | 60 |
| 5071-230 | Repeat Sternotomy Blade | 60 |
| 5057-040 | Repeat Sternotomy Saw, Pneumatic | 57 |
| 1365-005 | Replacement Hex Wrench for Micro 100 Sagittal & Oscillating Saw | 42 |
| 1375-021 | Rhinoplasty Guard | 43 |
| C9950 | Rhinotec Cuda Blade 2.0mm, 7.6cm Working Length, 6/Box | 69 |
| C9951 | Rhinotec Cuda Blade 2.9mm, 7.6cm Working Length, 6/Box | 69 |
| C9952 | Rhinotec Cuda Blade 3.5mm, 7.6cm Working Length, 6/Box | 69 |
| E9351 | Rhinotec Cuda Blade 3.7mm, Bendable to 30°, Irrigated, 10.5cm Working Length, 6/Box | 69 |
| E9350 | Rhinotec Cuda Blade 4.2mm, Bendable to 30°, Irrigated, 10.5cm Working Length, 6/Box | 69 |
| A9350 | Rhinotec Cuda Blade 4.2mm, Bendable to 45°, 10.5cm Working Length, 6/Box | 48 |
| N9210 | Rhinotec Cuda Blade 4.2mm, Irrigated, 10.5cm Working Length, 6/Box | 69 |
| C9960 | Rhinotec Gator Blade 2.0mm, 7.6cm Working Length, 6/Box | 70 |
| C9961 | Rhinotec Gator Blade 2.9mm, 7.6cm Working Length, 6/Box | 70 |
| C9962 | Rhinotec Gator Blade 3.5mm, 7.6cm Working Length, 6/Box | 80 |
| E9361 | Rhinotec Gator Blade 3.7mm, Bendable to 30°, Irrigated, 10.5cm Working Length, 6/Box | 67 |
| E9360 | Rhinotec Gator Blade 4.2mm, Bendable to 30°, Irrigated, 10.5cm Working Length, 6/Box | 67 |
| A9360 | Rhinotec Gator Blade 4.2mm, Bendable to 45°, 10.5cm Working Length, 6/Box | 48 |

| Cat. No. | Description | Page No. |
|----------|---|-----------------|
| N9220 | Rhinotec Gator Blade 4.2mm, Irrigated, 10.5cm Working Length, 6/Box | 68 |
| C9911 | Rhinotec Spherical Bur, 2.9mm, Hooded, 7.6cm Working Length, 6/ Box | 68 |
| C9912 | Rhinotec Spherical Bur, 3.5mm, Hooded, 7.6cm Working Length, 6/Box | 68 |
| N9382 | Rhinotec Spherical Bur, 3.5mm, Unhooded, 7.6cm Working Length, 6/Box | 13 |
| N9380 | Rhinotec Spherical Bur, 4.5mm, Hooded, 10.8cm Working Length, 6/Box | 70 |
| N9385 | Rhinotec Spherical Diamond Bur, 3.5mm, Hooded, 10.8cm Working Length, 6/Box | 13 |
| C9990 | Rhinotec Vortex Router 2.9mm, Hooded, 7.6cm Working Length, 6/Box | 80 |
| C9991 | Rhinotec Vortex Router 3.5mm, Hooded, 7.6cm Working Length, 6/Box | 80 |
| E8007 | Round Fluted E Bur | 72 |
| E8010 | Round Fluted E Bur | 72 |
| E8015 | Round Fluted E Bur | 72 |
| E8020 | Round Fluted E Bur | 72 |
| E8025 | Round Fluted E Bur | 72 |
| E8105 | Round Fluted E Bur | 72 |
| E8110 | Round Fluted E Bur | 72 |
| E8115 | Round Fluted E Bur | 72 |
| E8120 | Round Fluted E Bur | 72 |
| E8125 | Round Fluted E Bur | 72 |
| E8205 | Round Fluted E Bur | 72 |
| E8207 | Round Fluted E Bur | 72 |
| E8210 | Round Fluted E Bur | 72 |
| E8215 | Round Fluted E Bur | 72 |
| E8220 | Round Fluted E Bur | 72 |
| E8225 | Round Fluted E Bur | 72 |
| PRO2043 | Sagittal Saw Attachment | 13 |
| 5144-002 | Schrader Coupler | 82 |
| 7020-017 | Short Bur Guard (like Midas B-5) Black | 61, 67, 83, 84 |
| 7020-010 | Short Bur Guard (like Midas-X) Red | 61 - 66, 83, 84 |
| E9011-7 | Short Neuro Guard for E9010 Drill | 67, 73 |
| 7020-014 | Short Revision Extension (like Midas TU) Teal | 61 - 66, 83, 84 |
| PRO6100 | Single Trigger Modular Handpiece | 10 |
| PRO6150 | Single Trigger Modular Handpiece | 7 |
| PRO6200M | Single Trigger Modular Handpiece | 12 |
| PRO2038 | Small AO—Low Profile | 13 |
| PRO2138 | Small AO—One Handed Operation | 13 |
| PRO6000 | Small Bone Tray | 13 |
| 5030-028 | Small Holding Clamps | 79 |
| PRO3020 | Small NiCad Battery, 12 Volt | 9 |
| PRO3520 | Small NiMH Sterile Transfer Battery, 12 Volt | 9 |
| 6020-260 | Smartguard Irrigator | 42 |
| 5020-160 | Smartguard® | 42 |
| 5052-049 | Standard Bur Extension, Long, use with standard Cebotome Burs | 76 |
| 5052-048 | Standard Bur Extension, Medium, use with standard Cebotome Burs | 76, 86 |
| 5052-042 | Standard Bur Extension, Short, use with standard Cebotome Burs | 76, 86 |
| PRO2075 | Standard Hudson (DePuy) | 13 |
| 5052-012 | Standard Sterilization Case | 74, 79, 83 |
| 7007-03 | Staplizer Cartridge | 78 |
| 7010-03 | Staplizer Cartridge | 78 |
| 7015-03 | Staplizer Cartridge | 78 |
| 7307-03 | Staplizer Cartridge | 78 |
| 7310-03 | Staplizer Cartridge | 78 |
| 7315-03 | Staplizer Cartridge | 78 |
| 7320-03 | Staplizer Cartridge | 78 |
| 7610-03 | Staplizer Cartridge | 78 |
| 7615-03 | Staplizer Cartridge | 78 |

Alphabetical Index



| Cat. No. | Description | Page No. |
|-----------------|--|-----------------|
| 7620-03 | Staplizer Cartridge | 78 |
| 7625-03 | Staplizer Cartridge | 82 |
| 7707-03 | Staplizer Cartridge | 68 |
| 7710-03 | Staplizer Cartridge | 69 |
| 5059-006 | Sternum Guard, 2.25" (5.72mm), for PRO6450, PRO6450M | 57 |
| 5059-011 | Sternum Guard, 3.12" (7.92mm), for PRO6450, PRO6450M | 57 |
| 5059-031 | Sternum Saw Blade | 58 |
| 5059-031-01 | Sternum Saw Blade | 58 |
| 5059-032-01 | Sternum Saw Blade | 58 |
| 5059-233 | Sternum Saw Blade | 58 |
| 5059-235 | Sternum Saw Blade | 58 |
| 5059-531 | Sternum Saw Blade | 58 |
| 5059-532 | Sternum Saw Blade | 58 |
| 5059-007 | Sternum Saw Wrench, for PRO6450, PRO6450M & 5059-005 | 57 |
| 5072-100 | Stryker Large Bone Knee Blade | 27 |
| 5072-101 | Stryker Large Bone Knee Blade | 29 |
| 5072-102 | Stryker Large Bone Knee Blade | 27, 28 |
| 5072-105 | Stryker Large Bone Knee Blade | 28 |
| 5072-109 | Stryker Large Bone Knee Blade | 28 |
| 5072-110 | Stryker Large Bone Knee Blade | 29 |
| 5072-111 | Stryker Large Bone Knee Blade | 29 |
| 5072-140 | Stryker Large Bone Knee Blade | 27 |
| 5072-142 | Stryker Large Bone Knee Blade | 28 |
| 5072-143 | Stryker Large Bone Knee Blade | 27 |
| 5072-145 | Stryker Large Bone Knee Blade | 27 |
| 5072-150 | Stryker Large Bone Knee Blade | 27 |
| 5072-151 | Stryker Large Bone Knee Blade | 28 |
| 5072-152 | Stryker Large Bone Knee Blade | 28 |
| 5072-158 | Stryker Large Bone Knee Blade | 29 |
| 5072-176 | Stryker Large Bone Knee Blade | 30 |
| 5072-177 | Stryker Large Bone Knee Blade | 30 |
| 5072-181 | Stryker Large Bone Knee Blade | 29 |
| 5072-183 | Stryker Large Bone Knee Blade | 29 |
| 5072-185 | Stryker Large Bone Knee Blade | 29 |
| 5072-195 | Stryker Large Bone Knee Blade | 28 |
| 5072-218 | Stryker Large Bone Knee Blade | 29 |
| 5052-135 | Stryker Large Bone Reciprocating Blade | 39 |
| 5052-332 | Stryker Large Bone Reciprocating Blade | 39 |
| 5052-333 | Stryker Large Bone Reciprocating Blade | 39 |
| 5052-334 | Stryker Large Bone Reciprocating Blade | 39 |
| STK130-089-90 | Stryker Replacement Blade | 18 |
| STK130-119-90 | Stryker Replacement Blade | 18 |
| STK130-127-90 | Stryker Replacement Blade | 18 |
| STK190-089-90 | Stryker Replacement Blade | 18 |
| STK190-089-90 | Stryker Replacement Blade | 18 |
| STK190-127-05 | Stryker Replacement Blade | 18 |
| STK190-127-90 | Stryker Replacement Blade | 18 |
| STK190-137-90 | Stryker Replacement Blade | 18 |
| STK193-137-90 | Stryker Replacement Blade | 18 |
| STK193-137-90 | Stryker Replacement Blade | 18 |
| STK250-100-90 | Stryker Replacement Blade | 18 |
| STK250-119-90 | Stryker Replacement Blade | 18 |
| STK250-127-90 | Stryker Replacement Blade | 15 |
| STK250-137-90 | Stryker Replacement Blade | 15 |
| STK250-147-90 | Stryker Replacement Blade | 15 |

| Cat. No. | Description | Page No. |
|-----------------|--|-----------------|
| 5058-001 | Surgairtome Two Handpiece | 83 |
| 5058-001 | Surgairtome Two High Speed Drill | 42 |
| 5058-000 | Surgairtome Two High Speed Drill Kit (System listing on page xx) | 42 |
| 1387-022 | Tissue Retractor | 43, 54, 55 |
| PR03130 | Transfer Shroud for PR03110 | 9 |
| PR03531 | Transfer Shroud for PR03521 | 44 |
| 7021-094 | UltraPower Carbide Metal Cutting Bur | 64 |
| 7021-294 | UltraPower Carbide Metal Cutting Bur | 66 |
| 7021-297 | UltraPower Carbide Metal Cutting Bur | 63 |
| 7021-074 | UltraPower Coarse Round Diamond Bur | 65 |
| 7021-075 | UltraPower Coarse Round Diamond Bur | 65 |
| 7021-077 | UltraPower Coarse Round Diamond Bur | 66 |
| 7021-171 | UltraPower Coarse Round Diamond Bur | 63 |
| 7021-172 | UltraPower Coarse Round Diamond Bur | 63 |
| 7021-173 | UltraPower Coarse Round Diamond Bur | 63 |
| 7021-174 | UltraPower Coarse Round Diamond Bur | 63 |
| 7021-175 | UltraPower Coarse Round Diamond Bur | 65 |
| 7021-176 | UltraPower Coarse Round Diamond Bur | 65 |
| 7021-177 | UltraPower Coarse Round Diamond Bur | 65 |
| 7021-272 | UltraPower Coarse Round Diamond Bur | 63 |
| 7021-273 | UltraPower Coarse Round Diamond Bur | 63 |
| 7021-274 | UltraPower Coarse Round Diamond Bur | 63 |
| 7021-275 | UltraPower Coarse Round Diamond Bur | 65 |
| 7021-276 | UltraPower Coarse Round Diamond Bur | 65 |
| 7021-277 | UltraPower Coarse Round Diamond Bur | 65 |
| 7021-371 | UltraPower Coarse Round Diamond Bur | 63 |
| 7021-372 | UltraPower Coarse Round Diamond Bur | 63 |
| 7021-373 | UltraPower Coarse Round Diamond Bur | 63 |
| 7021-374 | UltraPower Coarse Round Diamond Bur | 63 |
| 7021-375 | UltraPower Coarse Round Diamond Bur | 65 |
| 7021-376 | UltraPower Coarse Round Diamond Bur | 65 |
| 7021-377 | UltraPower Coarse Round Diamond Bur | 65 |
| 7021-474 | UltraPower Coarse Round Diamond Bur | 66 |
| 7021-279 | UltraPower Fine Diamond Cylindrical Bur | 65 |
| 7021-378 | UltraPower Fine Diamond Cylindrical Bur | 65 |
| 7021-379 | UltraPower Fine Diamond Cylindrical Bur | 65 |
| 7021-092 | UltraPower Fine Diamond Wheel for Metal Cutting Bur | 66 |
| 7021-292 | UltraPower Fine Diamond Wheel for Metal Cutting Bur | 66 |
| 7021-392 | UltraPower Fine Diamond Wheel for Metal Cutting Bur | 63 |
| 7021-492 | UltraPower Fine Diamond Wheel for Metal Cutting Bur | 62 |
| 7021-062 | UltraPower Fine Round Diamond Bur | 62 |
| 7021-063 | UltraPower Fine Round Diamond Bur | 62 |
| 7021-064 | UltraPower Fine Round Diamond Bur | 63 |
| 7021-065 | UltraPower Fine Round Diamond Bur | 63 |
| 7021-066 | UltraPower Fine Round Diamond Bur | 63 |
| 7021-161 | UltraPower Fine Round Diamond Bur | 62 |
| 7021-162 | UltraPower Fine Round Diamond Bur | 62 |
| 7021-163 | UltraPower Fine Round Diamond Bur | 62 |
| 7021-164 | UltraPower Fine Round Diamond Bur | 62 |
| 7021-165 | UltraPower Fine Round Diamond Bur | 63 |
| 7021-166 | UltraPower Fine Round Diamond Bur | 63 |
| 7021-167 | UltraPower Fine Round Diamond Bur | 63 |
| 7021-261 | UltraPower Fine Round Diamond Bur | 62 |
| 7021-262 | UltraPower Fine Round Diamond Bur | 62 |
| 7021-263 | UltraPower Fine Round Diamond Bur | 62 |

Alphabetical Index



| Cat. No. | Description | Page No. |
|-------------|---|------------|
| 7021-264 | UltraPower Fine Round Diamond Bur | 62 |
| 7021-265 | UltraPower Fine Round Diamond Bur | 63 |
| 7021-266 | UltraPower Fine Round Diamond Bur | 63 |
| 7021-267 | UltraPower Fine Round Diamond Bur | 63 |
| 7021-361 | UltraPower Fine Round Diamond Bur | 62 |
| 7021-362 | UltraPower Fine Round Diamond Bur | 62 |
| 7021-363 | UltraPower Fine Round Diamond Bur | 62 |
| 7021-364 | UltraPower Fine Round Diamond Bur | 62 |
| 7021-365 | UltraPower Fine Round Diamond Bur | 63 |
| 7021-366 | UltraPower Fine Round Diamond Bur | 63 |
| 7021-367 | UltraPower Fine Round Diamond Bur | 63 |
| 7021-081 | UltraPower Fluted Acorn Bur | 66 |
| 7021-083 | UltraPower Fluted Acorn Bur | 66 |
| 7021-181 | UltraPower Fluted Acorn Bur | 66 |
| 7021-182 | UltraPower Fluted Acorn Bur | 66 |
| 7021-183 | UltraPower Fluted Acorn Bur | 63 |
| 7021-280 | UltraPower Fluted Acorn Bur | 65 |
| 7021-281 | UltraPower Fluted Acorn Bur | 66 |
| 7021-282 | UltraPower Fluted Acorn Bur | 66 |
| 7021-283 | UltraPower Fluted Acorn Bur | 66 |
| 7021-380 | UltraPower Fluted Acorn Bur | 65 |
| 7021-381 | UltraPower Fluted Acorn Bur | 66 |
| 7021-382 | UltraPower Fluted Acorn Bur | 66 |
| 7021-383 | UltraPower Fluted Acorn Bur | 66 |
| 7021-482 | UltraPower Fluted Acorn Bur | 63 |
| 7021-483 | UltraPower Fluted Acorn Bur | 62 |
| 7021-581 | UltraPower Fluted Acorn Bur | 62 |
| 7021-583 | UltraPower Fluted Acorn Bur | 62 |
| 7021-681 | UltraPower Fluted Acorn Bur | 73 |
| 7021-683 | UltraPower Fluted Acorn Bur | 64 |
| 7021-036 | UltraPower Fluted Cylindrical Bur | 66 |
| 7021-037 | UltraPower Fluted Cylindrical Bur | 66 |
| 7021-136 | UltraPower Fluted Cylindrical Bur | 66 |
| 7021-137 | UltraPower Fluted Cylindrical Bur | 66 |
| 7021-235 | UltraPower Fluted Cylindrical Bur | 64 |
| 7021-236 | UltraPower Fluted Cylindrical Bur | 65 |
| 7021-237 | UltraPower Fluted Cylindrical Bur | 65 |
| 7021-335 | UltraPower Fluted Cylindrical Bur | 64 |
| 7021-336 | UltraPower Fluted Cylindrical Bur | 62 |
| 7021-337 | UltraPower Fluted Cylindrical Bur | 62 |
| 7021-338 | UltraPower Fluted Cylindrical Bur | 62 |
| 7021-437 | UltraPower Fluted Cylindrical Bur | 65 |
| 7021-391 | UltraPower Fluted Frustrum Bur | 66 |
| 7021-141-35 | UltraPower Fluted Frustrum Bur – Depth Limiting | 66 |
| 7021-141-50 | UltraPower Fluted Frustrum Bur – Depth Limiting | 64 |
| 7021-141-90 | UltraPower Fluted Frustrum Bur – Depth Limiting | 66 |
| 7021-145-70 | UltraPower Fluted Frustrum Bur – Depth Limiting | 62 |
| 7020-045 | Ultrapower Footswitch | 67, 83, 84 |
| 7020-001 | Ultrapower High Speed Drill | 61, 83, 84 |
| 7020-002 | Ultrapower Low Speed Drill | 61, 83, 84 |
| 7021-095 | UltraPower Oval Fluted Bur | 64 |
| 7021-096 | UltraPower Oval Fluted Bur | 64 |
| 7021-195 | UltraPower Oval Fluted Bur | 63 |
| 7021-196 | UltraPower Oval Fluted Bur | 63 |
| 7021-295 | UltraPower Oval Fluted Bur | 64 |

| Cat. No. | Description | Page No. |
|-----------------|-----------------------------|-----------------|
| 7021-296 | UltraPower Oval Fluted Bur | 63 |
| 7021-395 | UltraPower Oval Fluted Bur | 63 |
| 7021-396 | UltraPower Oval Fluted Bur | 62 |
| 7020-003 | Ultrapower Perforator Drive | 61, 83, 84 |
| 7021-024 | UltraPower Round Fluted Bur | 62 |
| 7021-025 | UltraPower Round Fluted Bur | 62 |
| 7021-026 | UltraPower Round Fluted Bur | 62 |
| 7021-027 | UltraPower Round Fluted Bur | 62 |
| 7021-028 | UltraPower Round Fluted Bur | 62 |
| 7021-029 | UltraPower Round Fluted Bur | 62 |
| 7021-030 | UltraPower Round Fluted Bur | 62 |
| 7021-031 | UltraPower Round Fluted Bur | 62 |
| 7021-032 | UltraPower Round Fluted Bur | 64 |
| 7021-033 | UltraPower Round Fluted Bur | 64 |
| 7021-034 | UltraPower Round Fluted Bur | 66 |
| 7021-122 | UltraPower Round Fluted Bur | 62 |
| 7021-123 | UltraPower Round Fluted Bur | 62 |
| 7021-124 | UltraPower Round Fluted Bur | 62 |
| 7021-125 | UltraPower Round Fluted Bur | 62 |
| 7021-126 | UltraPower Round Fluted Bur | 62 |
| 7021-127 | UltraPower Round Fluted Bur | 62 |
| 7021-128 | UltraPower Round Fluted Bur | 62 |
| 7021-129 | UltraPower Round Fluted Bur | 62 |
| 7021-130 | UltraPower Round Fluted Bur | 62 |
| 7021-131 | UltraPower Round Fluted Bur | 62 |
| 7021-132 | UltraPower Round Fluted Bur | 64 |
| 7021-133 | UltraPower Round Fluted Bur | 64 |
| 7021-134 | UltraPower Round Fluted Bur | 66 |
| 7021-220 | UltraPower Round Fluted Bur | 62 |
| 7021-222 | UltraPower Round Fluted Bur | 62 |
| 7021-223 | UltraPower Round Fluted Bur | 62 |
| 7021-224 | UltraPower Round Fluted Bur | 62 |
| 7021-225 | UltraPower Round Fluted Bur | 62 |
| 7021-226 | UltraPower Round Fluted Bur | 62 |
| 7021-227 | UltraPower Round Fluted Bur | 62 |
| 7021-228 | UltraPower Round Fluted Bur | 62 |
| 7021-229 | UltraPower Round Fluted Bur | 62 |
| 7021-230 | UltraPower Round Fluted Bur | 62 |
| 7021-231 | UltraPower Round Fluted Bur | 64 |
| 7021-232 | UltraPower Round Fluted Bur | 64 |
| 7021-233 | UltraPower Round Fluted Bur | 64 |
| 7021-322 | UltraPower Round Fluted Bur | 62 |
| 7021-323 | UltraPower Round Fluted Bur | 62 |
| 7021-324 | UltraPower Round Fluted Bur | 62 |
| 7021-325 | UltraPower Round Fluted Bur | 62 |
| 7021-326 | UltraPower Round Fluted Bur | 62 |
| 7021-327 | UltraPower Round Fluted Bur | 62 |
| 7021-328 | UltraPower Round Fluted Bur | 62 |
| 7021-329 | UltraPower Round Fluted Bur | 62 |
| 7021-331 | UltraPower Round Fluted Bur | 64 |
| 7021-332 | UltraPower Round Fluted Bur | 64 |
| 7021-333 | UltraPower Round Fluted Bur | 64 |
| 7021-426 | UltraPower Round Fluted Bur | 62 |
| 7021-427 | UltraPower Round Fluted Bur | 62 |
| 7021-428 | UltraPower Round Fluted Bur | 62 |

Alphabetical Index



| Cat. No. | Description | Page No. |
|----------|-----------------------------|----------|
| 7021-429 | UltraPower Round Fluted Bur | 62 |
| 7021-431 | UltraPower Round Fluted Bur | 64 |
| 7021-432 | UltraPower Round Fluted Bur | 63 |
| 7021-433 | UltraPower Round Fluted Bur | 65 |
| 7021-526 | UltraPower Round Fluted Bur | 62 |
| 7021-528 | UltraPower Round Fluted Bur | 62 |
| 7021-529 | UltraPower Round Fluted Bur | 62 |
| 7021-531 | UltraPower Round Fluted Bur | 65 |
| 7021-532 | UltraPower Round Fluted Bur | 65 |
| 7021-533 | UltraPower Round Fluted Bur | 62 |
| 7021-631 | UltraPower Round Fluted Bur | 65 |
| 7021-632 | UltraPower Round Fluted Bur | 65 |
| 7021-633 | UltraPower Round Fluted Bur | 64 |
| 7021-012 | UltraPower Side Cutting Bur | 62, 64 |
| 7021-013 | UltraPower Side Cutting Bur | 62 |
| 7021-015 | UltraPower Side Cutting Bur | 62 |
| 7021-043 | UltraPower Side Cutting Bur | 62 |
| 7021-112 | UltraPower Side Cutting Bur | 64 |
| 7021-113 | UltraPower Side Cutting Bur | 64 |
| 7021-114 | UltraPower Side Cutting Bur | 64 |
| 7021-115 | UltraPower Side Cutting Bur | 62 |
| 7021-116 | UltraPower Side Cutting Bur | 62 |
| 7021-119 | UltraPower Side Cutting Bur | 62 |
| 7021-143 | UltraPower Side Cutting Bur | 62 |
| 7021-202 | UltraPower Side Cutting Bur | 63 |
| 7021-206 | UltraPower Side Cutting Bur | 64 |
| 7021-207 | UltraPower Side Cutting Bur | 64 |
| 7021-210 | UltraPower Side Cutting Bur | 62 |
| 7021-214 | UltraPower Side Cutting Bur | 62 |
| 7021-218 | UltraPower Side Cutting Bur | 62 |
| 7021-243 | UltraPower Side Cutting Bur | 65 |
| 7021-301 | UltraPower Side Cutting Bur | 63 |
| 7021-302 | UltraPower Side Cutting Bur | 63 |
| 7021-303 | UltraPower Side Cutting Bur | 63 |
| 7021-305 | UltraPower Side Cutting Bur | 64 |
| 7021-309 | UltraPower Side Cutting Bur | 64 |
| 7021-310 | UltraPower Side Cutting Bur | 64 |
| 7021-314 | UltraPower Side Cutting Bur | 62 |
| 7021-315 | UltraPower Side Cutting Bur | 62 |
| 7021-318 | UltraPower Side Cutting Bur | 62 |
| 7021-408 | UltraPower Side Cutting Bur | 62 |
| 7021-409 | UltraPower Side Cutting Bur | 63 |
| 7021-427 | UltraPower Side Cutting Bur | 62 |
| 7021-509 | UltraPower Side Cutting Bur | 62 |
| 7021-713 | UltraPower Side Cutting Bur | 64, 73 |
| 7021-815 | UltraPower Side Cutting Bur | 73 |
| 7021-917 | UltraPower Side Cutting Bur | 78 |
| 7021-051 | UltraPower Trepine Bur | 62 |
| 7021-250 | UltraPower Trepine Bur | 65 |
| 7021-252 | UltraPower Trepine Bur | 62 |
| 7021-253 | UltraPower Trepine Bur | 62 |
| 7021-255 | UltraPower Trepine Bur | 62 |
| 7021-040 | UltraPower Wire Pass Bur | 64 |
| 7021-041 | UltraPower Wire Pass Bur | 65 |
| 7021-042 | UltraPower Wire Pass Bur | 62 |

| Cat. No. | Description | Page No. |
|-----------------|--|-----------------|
| 7021-140 | UltraPower Wire Pass Bur | 66 |
| 7021-141 | UltraPower Wire Pass Bur | 66 |
| 7021-142 | UltraPower Wire Pass Bur | 62 |
| 5052-010 | Universal Hose, 10' (3.05m) | 76, 82 - 84, 86 |
| 5053-019 | Wire Driver Adapter Chuck for use with 5053-013 | 42 |
| PRO6228 | Wire Driver Range: 0.7 – 1.6mm (0.028 – 0.062") | 7 |
| PRO6128 | Wire Driver, Range: 0.7 – 1.6mm (0.028 – 0.062") | 11 |
| 5053-123 | Wire Guard for use with 5053-013 | 42 |
| 5056-184 | Wire Pass Osteon Bur | 75 |
| 5056-185 | Wire Pass Osteon Bur | 75 |
| 5056-186 | Wire Pass Osteon Bur | 75 |
| E4110 | Wirepass E Bur | 73 |
| E4115 | Wirepass E Bur | 73 |
| E4120 | Wirepass E Bur | 73 |
| PRO3011 | X-Large NiCad Battery, 12 Volt | 9 |
| 1375-023 | X-Long Bur Guard | 43, 54, 55, 56 |
| 7020-013 | X-Long Bur Guard (like Midas-AM/A) Lime | 61 - 66, 83, 84 |
| E9011-3 | X-Long Bur Guard for E9010 Drill | 67 |
| 1375-023P | X-Long Precision Bur Guard | 43 |
| 1375-040 | Y Connector | 82 |
| PRO2046 | Zimmer/Hudson | 13 |



Hall® Powered
Instruments System™
Product Catalog

525 French Road
Utica, New York 13502

Local 727-392-6464
Toll Free 1-800-237-0169

ConMed.com
customer_service@conmed.com

HALL®
POWERED INSTRUMENTS